

## STERILE CONTAINER SYSTEMS



## BASKETS

BASKET MADE FROM STAINLESS STEEL WIRE MESH

WIRE BASKET WITH LID

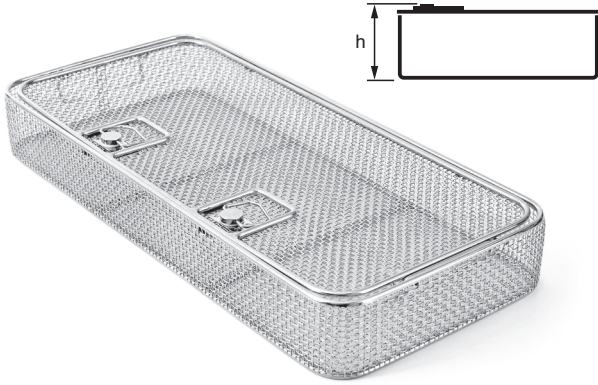

code	outside dimension
<b>K3-1010</b>	540 x 245 h:35 mm
<b>K3-1011</b>	540 x 245 h:55 mm
<b>K3-1012</b>	540 x 245 h:75 mm
<b>K3-1013</b>	540 x 245 h:105 mm
<b>K3-1014</b>	ONLY LID, for baskets

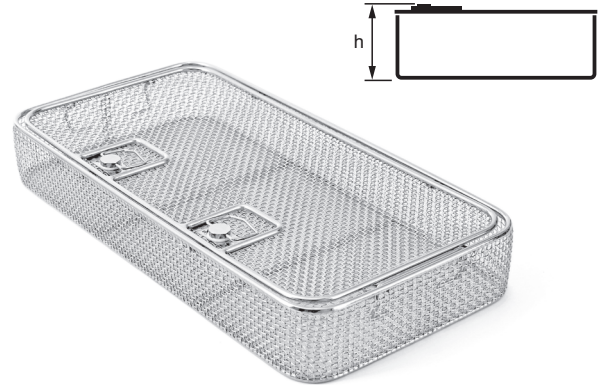

code	outside dimension
<b>K3-1020</b>	480 x 245 h:35 mm
<b>K3-1021</b>	480 x 245 h:55 mm
<b>K3-1022</b>	480 x 245 h:75 mm
<b>K3-1023</b>	480 x 245 h:105 mm
<b>K3-1024</b>	ONLY LID, for baskets

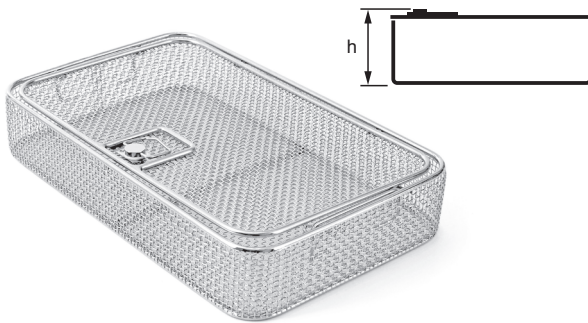

code	outside dimension
<b>K3-1030</b>	405 x 245 h:35 mm
<b>K3-1031</b>	405 x 245 h:55 mm
<b>K3-1032</b>	405 x 245 h:75 mm
<b>K3-1033</b>	405 x 245 h:105 mm
<b>K3-1034</b>	ONLY LID, for baskets

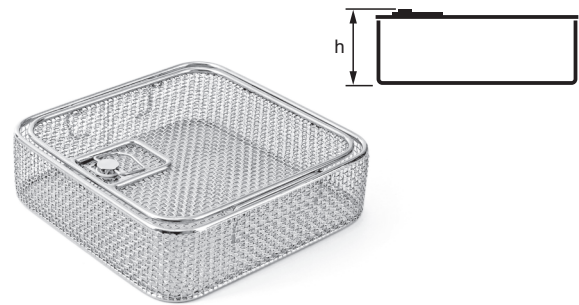

code	outside dimension
<b>K3-1040</b>	246 x 246 h:35 mm
<b>K3-1041</b>	246 x 246 h:55 mm
<b>K3-1042</b>	246 x 246 h:75 mm
<b>K3-1043</b>	246 x 246 h:105 mm
<b>K3-1045</b>	ONLY LID, for baskets

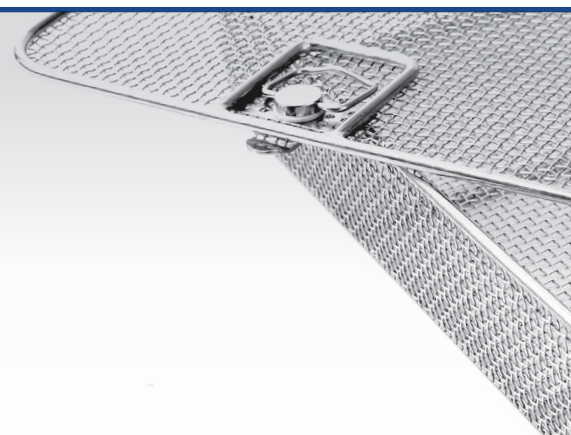

Mesh grid

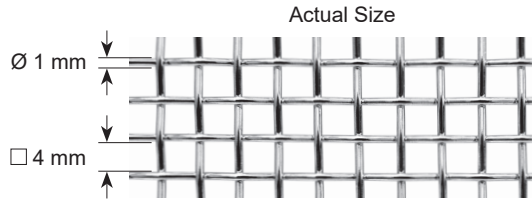

WIRE BASKETS

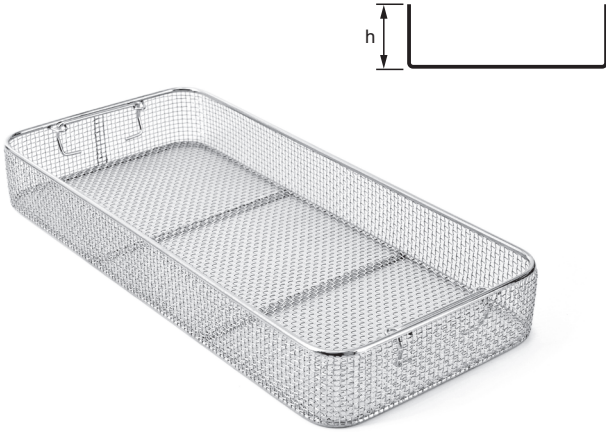

code	outside dimension
<b>K2-460</b>	540 x 245 h:30 mm
<b>K2-461</b>	540 x 245 h:50 mm
<b>K2-462</b>	540 x 245 h:70 mm
<b>K2-463</b>	540 x 245 h:100 mm

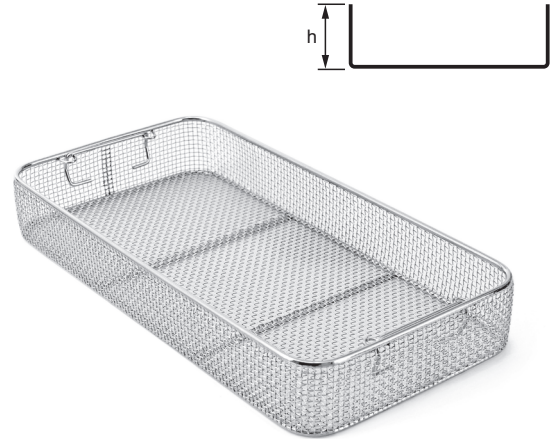

code	outside dimension
<b>K2-450</b>	480 x 245 h:30 mm
<b>K2-451</b>	480 x 245 h:50 mm
<b>K2-452</b>	480 x 245 h:70 mm
<b>K2-453</b>	480 x 245 h:100 mm

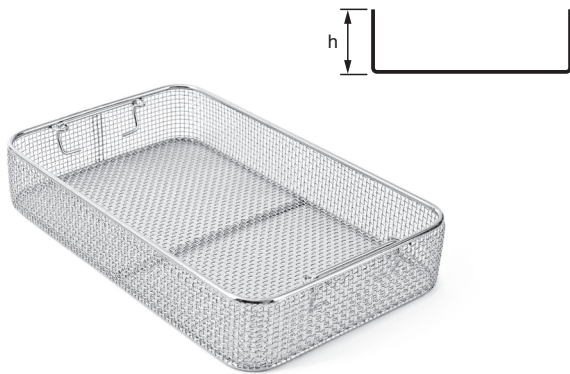

code	outside dimension
<b>K2-1500</b>	405 x 245 x h:30 mm
<b>K2-1501</b>	405 x 245 x h:50 mm
<b>K2-1502</b>	405 x 245 x h:70 mm
<b>K2-1503</b>	405 x 245 x h:100 mm

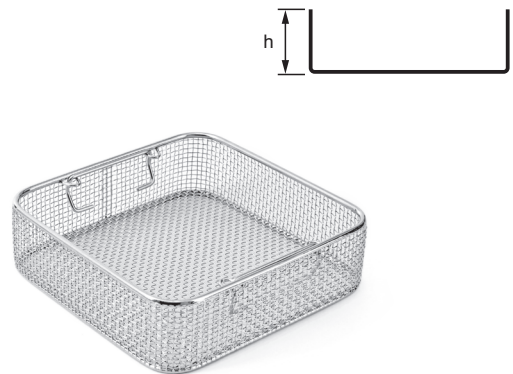

code	outside dimension
<b>K2-490</b>	246 x 246 x h:30 mm
<b>K2-491</b>	246 x 246 x h:50 mm
<b>K2-492</b>	246 x 246 x h:70 mm
<b>K2-493</b>	246 x 246 x h:100 mm

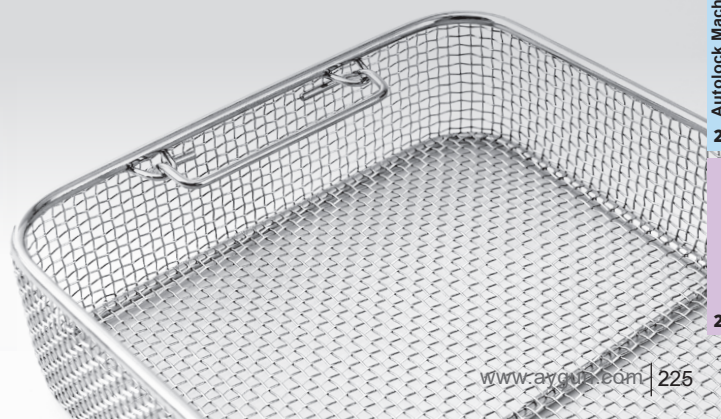

STANDARD MODEL	29
BIO-BARRIER MODEL	63
Polymer's PPSU Lids	97
WINDOW MODEL	119
B <sub>3</sub> Barrier MODEL	139
PLASMA MODEL	173
A1 MODEL	185
Dental, Mini, Special	205
BASKETS	223
Autolock Mechanism Emulating Indicator	243
ACCESSORIES	251

BASKET MADE FROM STAINLESS STEEL WIRE MESH

WIRE BASKET WITH LID



code	outside dimension
<b>K3-2010</b>	300 x 220 h:55 mm
<b>K3-2011</b>	300 x 220 h:75 mm
<b>K3-2012</b>	300 x 220 h:105 mm
<b>K3-2013</b>	ONLY LID, for baskets



code	outside dimension
<b>K3-1704</b>	533 x 337 h:55 mm
<b>K3-1705</b>	533 x 337 h:75 mm
<b>K3-1706</b>	533 x 337 h:105 mm
<b>K3-1707</b>	ONLY LID, for baskets



code	outside dimension
<b>K3-1804</b>	665 x 250 h:55 mm
<b>K3-1805</b>	665 x 250 h:75 mm
<b>K3-1806</b>	665 x 250 h:105 mm
<b>K3-1807</b>	ONLY LID, for baskets

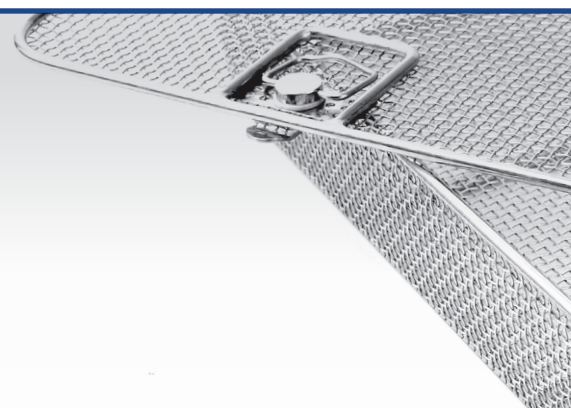

*Mesh grid*

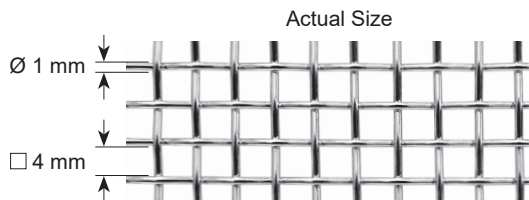

WIRE BASKETS



code	outside dimension
<b>K3-2000</b>	300 x 220 h:50 mm
<b>K3-2001</b>	300 x 220 h:70 mm
<b>K3-2002</b>	300 x 220 h:100 mm



code	outside dimension
<b>K2-1701</b>	533 x 337 h:50 mm
<b>K2-1702</b>	533 x 337 h:70 mm
<b>K2-1703</b>	533 x 337 h:100 mm



code	outside dimension
<b>K2-1801</b>	665 x 250 h:50 mm
<b>K2-1802</b>	665 x 250 h:70 mm
<b>K2-1803</b>	665 x 250 h:100 mm

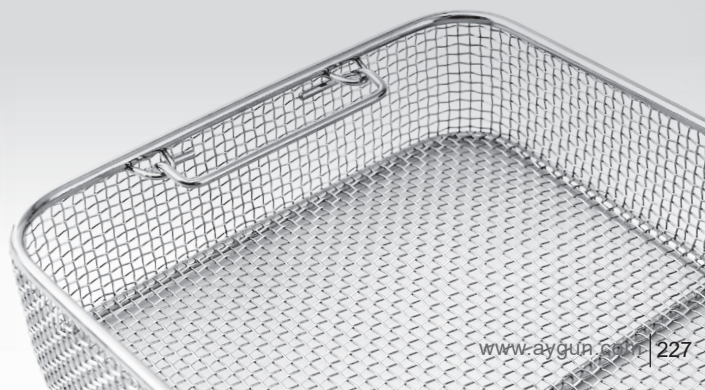
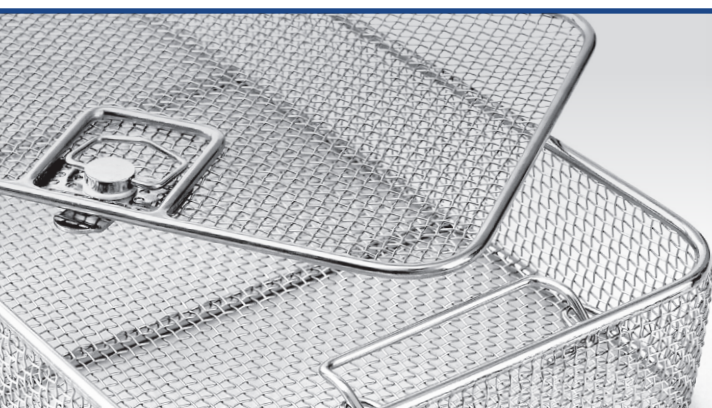

STANDARD MODEL  
29

BIO-BARRIER MODEL  
63

Polymer's PPSU Lids  
97

WINDOW MODEL  
119

B<sub>3</sub> Barrier MODEL  
139

PLASMA MODEL  
173

A1 MODEL  
185

Dental, Mini, Special  
205

BASKETS  
223

Autolock Mechanism Emulating Indicator  
243

ACCESSORIES  
251

WIRE BASKET WITH PERFORATED METAL PLATE

WIRE BASKET WITH LID



code	outside dimension
<b>K3-1011 P</b>	540 x 245 h:55 mm
<b>K3-1012 P</b>	540 x 245 h:75 mm
<b>K3-1013 P</b>	540 x 245 h:105 mm
<b>K3-1014 P</b>	ONLY LID, for baskets



code	outside dimension
<b>K3-1021 P</b>	480 x 245 h:55 mm
<b>K3-1022 P</b>	480 x 245 h:75 mm
<b>K3-1023 P</b>	480 x 245 h:105 mm
<b>K3-1024 P</b>	ONLY LID, for baskets

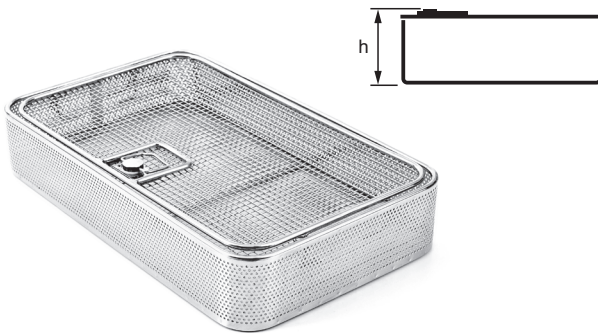

code	outside dimension
<b>K3-1031 P</b>	405 x 246 x h:55 mm
<b>K3-1032 P</b>	405 x 246 x h:75 mm
<b>K3-1033 P</b>	405 x 246 x h:105 mm
<b>K3-1034 P</b>	ONLY LID, for baskets

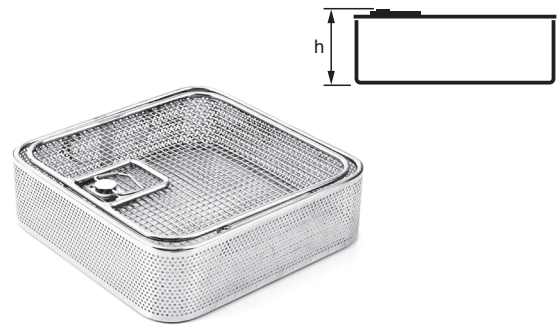

code	outside dimension
<b>K3-1041 P</b>	246 x 246 x h:55 mm
<b>K3-1042 P</b>	246 x 246 x h:75 mm
<b>K3-1043 P</b>	246 x 246 x h:105 mm
<b>K3-1045 P</b>	ONLY LID, for baskets

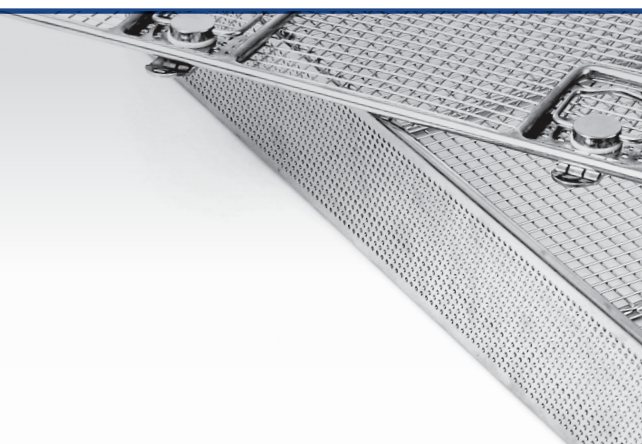

Side Plate  
304 ss sheet

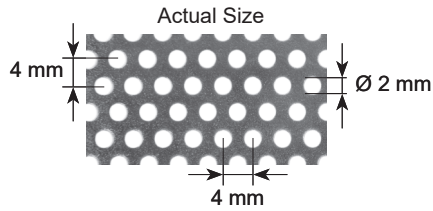

Base  
304 ss wire mesh

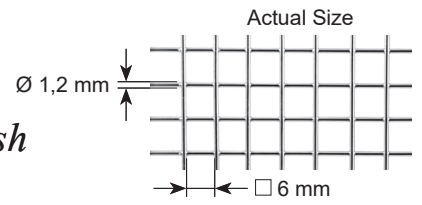

WIRE BASKETS



code	outside dimension
<b>K2-461 P</b>	540 x 245 h:50 mm
<b>K2-462 P</b>	540 x 245 h:70 mm
<b>K2-463 P</b>	540 x 245 h:100 mm



code	outside dimension
<b>K2-451 P</b>	480 x 245 h:50 mm
<b>K2-452 P</b>	480 x 245 h:70 mm
<b>K2-453 P</b>	480 x 245 h:100 mm



code	outside dimension
<b>K2-1501 P</b>	405 x 246 x h:50 mm
<b>K2-1502 P</b>	405 x 246 x h:70 mm
<b>K2-1503 P</b>	405 x 246 x h:100 mm







code	outside dimension
<b>K2-491 P</b>	246 x 246 x h:50 mm
<b>K2-492 P</b>	246 x 246 x h:70 mm
<b>K2-493 P</b>	246 x 246 x h:100 mm



STANDARD MODEL	29
BIO-BARRIER MODEL	63
Polymer's PPSU Lids	97
WINDOW MODEL	119
B <sub>3</sub> Barrier MODEL	139
PLASMA MODEL	173
A1 MODEL	185
Dental, Mini, Special	205
BASKETS	223
Autolock Mechanism Emulating Indicator	243
ACCESSORIES	251

BASKET MADE FROM STAINLESS STEEL SHEET (WITH STAND)

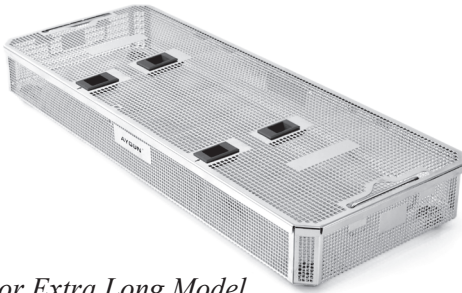
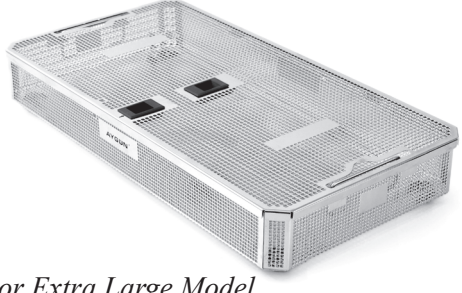
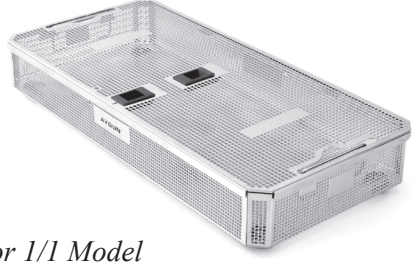
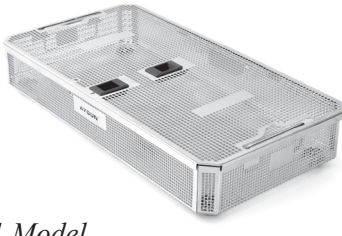
Sizes	Specifications	h=1 (mm)	h=2 (mm)	Box and Lid	Box	Lid
						
671 x 259 x h  ▶ For Extra Long Model		40 mm	44 mm	<b>K3-715</b>	<b>K3-711</b>	<b>K3-710</b>
		60 mm	64 mm	<b>K3-716</b>	<b>K3-712</b>	
		80 mm	84 mm	<b>K3-717</b>	<b>K3-713</b>	
		110 mm	114 mm	<b>K3-718</b>	<b>K3-714</b>	
539 x 346 x h  ▶ For Extra Large Model		40 mm	44 mm	<b>K3-701</b>	<b>K3-705</b>	<b>K3-709</b>
		60 mm	64 mm	<b>K3-702</b>	<b>K3-706</b>	
		80 mm	84 mm	<b>K3-703</b>	<b>K3-707</b>	
		110 mm	114 mm	<b>K3-704</b>	<b>K3-708</b>	
546 x 259 x h  ▶ For 1/1 Model		40 mm	44 mm	<b>K3-720</b>	<b>K3-740</b>	<b>K3-760</b>
		60 mm	64 mm	<b>K3-721</b>	<b>K3-741</b>	
		80 mm	84 mm	<b>K3-722</b>	<b>K3-742</b>	
		110 mm	114 mm	<b>K3-723</b>	<b>K3-743</b>	
491 x 259 x h  ▶ For 1/1 Model		40 mm	44 mm	<b>K3-724</b>	<b>K3-744</b>	<b>K3-761</b>
		60 mm	64 mm	<b>K3-725</b>	<b>K3-745</b>	
		80 mm	84 mm	<b>K3-726</b>	<b>K3-746</b>	
		110 mm	114 mm	<b>K3-727</b>	<b>K3-747</b>	

▶ The baskets which are without lid and less than 44 mm in height do not include the handles while the ones with lid include the handles.

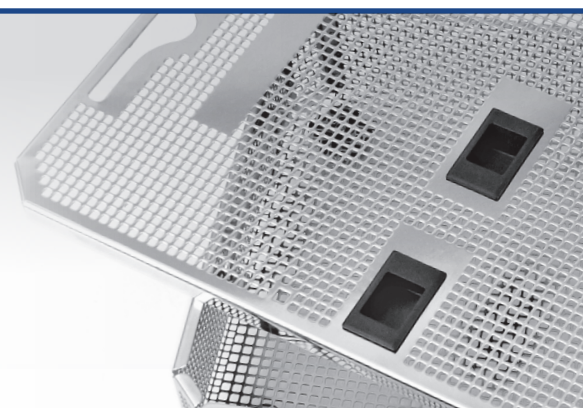





Sizes	Specifications	h=1 (mm)	h=2 (mm)	Box and Lid	Box	Lid
411 x 259 x h ► For 3/4 Model		40 mm	44 mm	<b>K3-728</b>	<b>K3-748</b>	<b>K3-762</b>
		60 mm	64 mm	<b>K3-729</b>	<b>K3-749</b>	
		80 mm	84 mm	<b>K3-730</b>	<b>K3-750</b>	
		110 mm	114 mm	<b>K3-731</b>	<b>K3-751</b>	
250 x 259 x h ► For 1/2 Model		40 mm	44 mm	<b>K3-732</b>	<b>K3-752</b>	<b>K3-763</b>
		60 mm	64 mm	<b>K3-733</b>	<b>K3-753</b>	
		80 mm	84 mm	<b>K3-734</b>	<b>K3-754</b>	
		110 mm	114 mm	<b>K3-735</b>	<b>K3-755</b>	
320 x 220 x h ► For Large Dental Model		60 mm	63 mm	<b>K3-774</b>	<b>K3-771</b>	<b>K3-770</b>
		80 mm	83 mm	<b>K3-775</b>	<b>K3-772</b>	
		110 mm	113 mm	<b>K3-776</b>	<b>K3-773</b>	
275 x 175 x h ► For Dental Model		45 mm	53 mm	<b>K3-736</b>	<b>K3-756</b>	<b>K3-764</b>
		105 mm	113 mm	<b>K3-737</b>	<b>K3-757</b>	
265 x 125 x h ► For Small Model		60 mm	63 mm	<b>K3-738</b>	<b>K3-758</b>	<b>K3-765</b>



↻ The baskets which are without lid and less than 44 mm in height do not include the handles while the ones with lid include the handles.

**STAND**



code	height
<b>K3-767</b>	20 mm

**STAND**





code	height
<b>K3-768</b>	10 mm

**STAND**

code	height
<b>K3-766</b>	5 mm

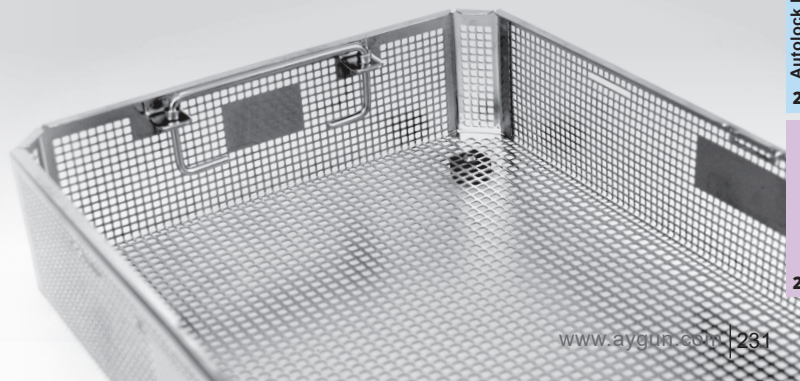
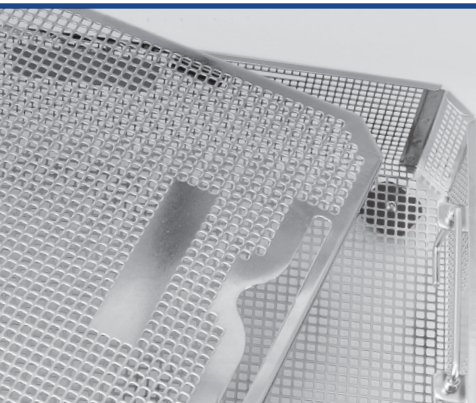

STANDARD MODEL	29
BIO-BARRIER MODEL	63
Polymer's PPSU Lids	97
WINDOW MODEL	119
B <sub>3</sub> Barrier MODEL	139
PLASMA MODEL	173
A1 MODEL	185
Dental, Mini, Special	205
BASKETS	223
Autolock Mechanism Emulating Indicator	243
ACCESSORIES	251

DENTAL BASKETS & TRAYS



code	outside dimension
<b>K3-780K</b>	274 x 180 x 34 mm

Basket with silicone fixation systems  
Holds 17 instruments with Ø 5 mm



code	outside dimension
<b>K3-780</b>	274 x 180 x 32 mm

Without silicone fixation systems

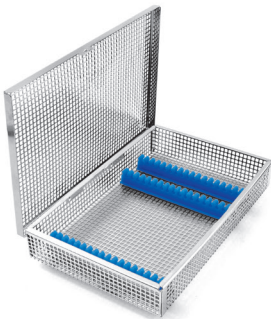

code	outside dimension
<b>K3-781K</b>	274 x 180 x 44 mm

Basket with silicone fixation systems  
Holds 17 instruments with Ø 5 mm



code	outside dimension
<b>K3-781</b>	274 x 180 x 42 mm
<b>K3-782</b>	274 x 180 x 62 mm

Without silicone fixation systems

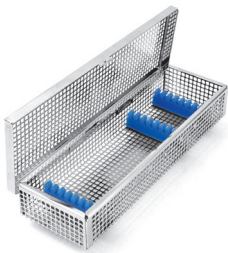

code	outside dimension
<b>K3-783K</b>	274 x 88 x 46 mm

Basket with silicone fixation systems  
Holds 8 instruments with Ø 5 mm



code	outside dimension
<b>K3-784K</b>	240 x 76 x 30 mm

Basket with blue silicone mat

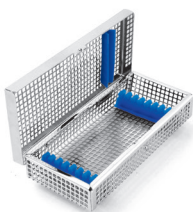

code	outside dimension
<b>K3-785K</b>	188 x 86 x 36 mm

Basket with silicone fixation systems  
Holds 8 instruments with Ø 5 mm

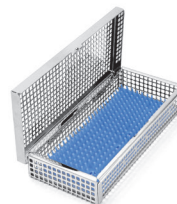

code	outside dimension
<b>K3-785</b>	188 x 86 x 32 mm

Basket with blue silicone mat



code	outside dimension
<b>K3-787</b>	138 x 124 x 48 mm

Without silicone fixation systems



code	outside dimension
<b>K3-788</b>	146 x 46 x 28 mm

Without silicone fixation systems



code	outside dimension
<b>K3-789</b>	86 x 46 x 28 mm

Without silicone fixation systems  
Bottom 2 mm, lid 4 mm perforation



code	outside dimension
<b>K3-786K</b>	191 x 130 x 36 mm

Basket with silicone fixation systems  
Holds 12 instruments with Ø 5 mm



code	outside dimension
<b>K3-786</b>	191 x 130 x 34 mm

Without silicone fixation systems

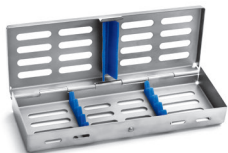

code	outside dimension
<b>K3-790K</b>	186 x 72 x 24 mm

Tray with silicone fixation system.  
Holds 5 instruments.



code	outside dimension
<b>K3-791K</b>	186 x 99 x 24 mm

Tray with silicone fixation system.  
Holds 7 instruments.



code	outside dimension
<b>K3-792K</b>	186 x 137 x 24 mm

Tray with silicone fixation system.  
Holds 10 instruments.

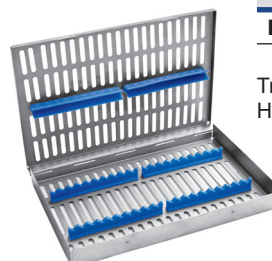

code	outside dimension
<b>K3-793K</b>	286 x 192 x 34 mm

Tray with silicone fixation system.  
Holds 20 instruments.

STANDARD  
MODEL  
29

BIO-BARRIER  
MODEL  
63

Polymer's PPSU  
Lids  
97

WINDOW  
MODEL  
119

B<sub>3</sub><sup>Barrier</sup>  
MODEL  
139

PLASMA  
MODEL  
173

A1  
MODEL  
185

Dental, Mini,  
Special  
205

BASKETS  
223

Autolock Mechanism  
Emulating Indicator  
243

ACCESSORIES  
251

WIRE BASKETS

Mesh grid

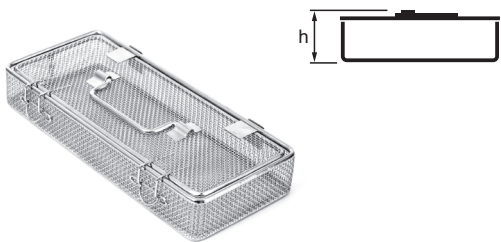
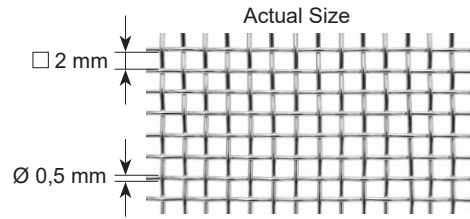

code	outside dimension
<b>K2-993</b>	268 x 127 x h:47 mm

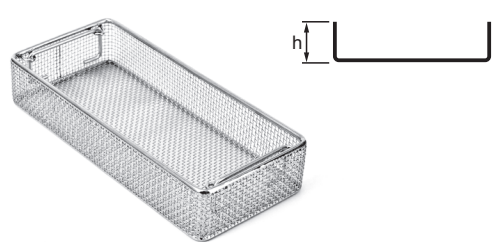

code	outside dimension
<b>K3-1073</b>	268 x 117 x h:50 mm

WIRE BASKETS

Mesh grid

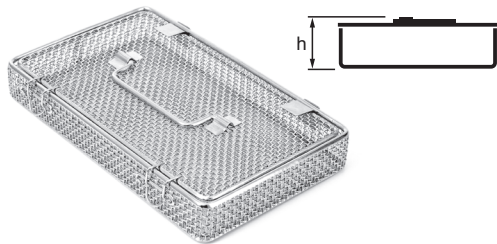
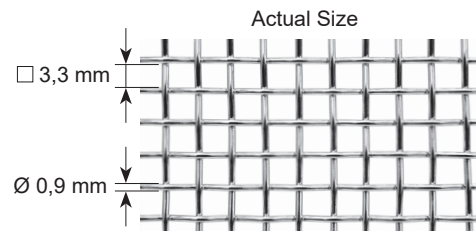

code	outside dimension
<b>K3-611</b>	270 x 175 x h:45 mm

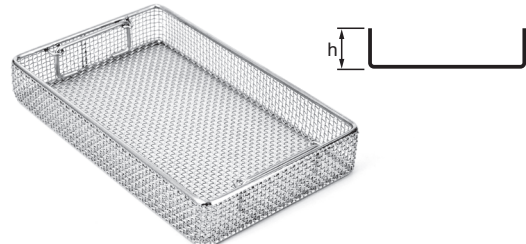

code	outside dimension
<b>K3-1070</b>	270 x 170 x h:45 mm

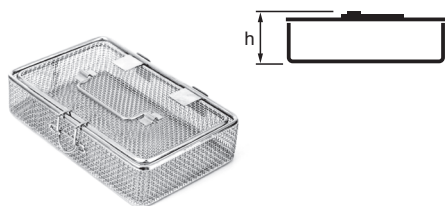

code	outside dimension
<b>K2-995</b>	175 x 153 x h:45 mm



code	outside dimension
<b>K3-1079</b>	175 x 144 x h:30 mm

## SMALL FINE MESH BASKETS WITH LID

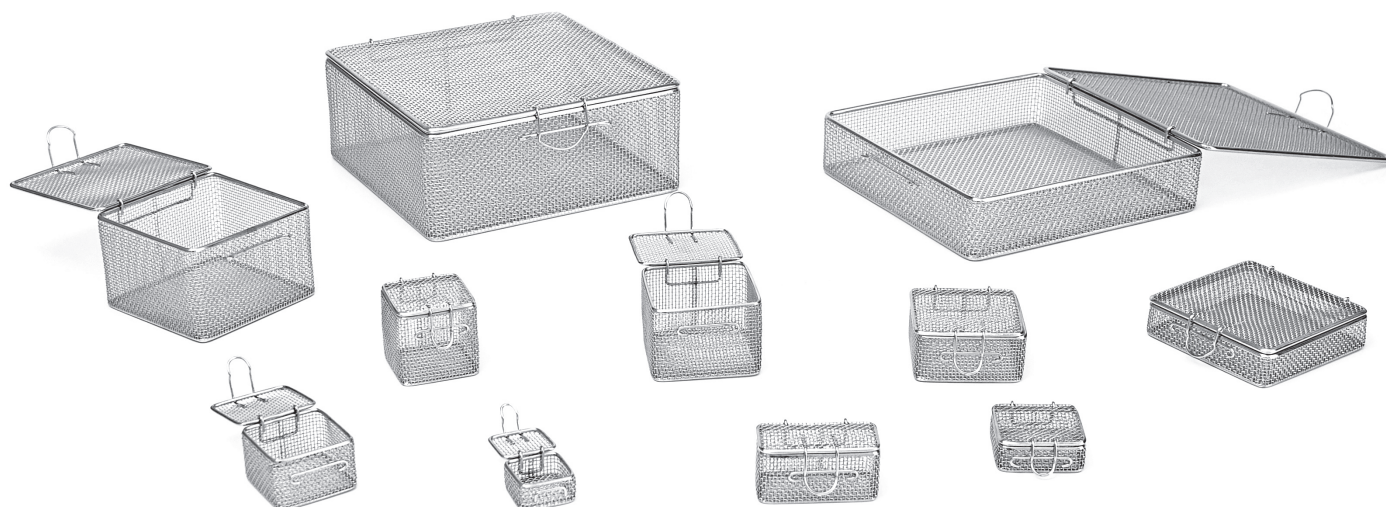

code	outside dimension
<b>K3-1100</b>	30 x 30 x 30 mm
<b>K3-1101</b>	40 x 40 x 20 mm
<b>K3-1102</b>	40 x 40 x 40 mm
<b>K3-1103</b>	60 x 60 x 20 mm
<b>K3-1104</b>	60 x 60 x 40 mm
<b>K3-1105</b>	60 x 60 x 60 mm
<b>K3-1106</b>	80 x 80 x 20 mm
<b>K3-1107</b>	80 x 40 x 40 mm
<b>K3-1108</b>	80 x 80 x 40 mm
<b>K3-1109</b>	80 x 80 x 60 mm
<b>K3-1110</b>	80 x 80 x 80 mm
<b>K3-1111</b>	100 x 100 x 10 mm
<b>K3-1112</b>	120 x 120 x 30 mm
<b>K3-1113</b>	120 x 120 x 60 mm
<b>K3-1114</b>	120 x 120 x 80 mm
<b>K3-1115</b>	240 x 240 x 30 mm
<b>K3-1116</b>	240 x 240 x 60 mm
<b>K3-1117</b>	240 x 240 x 80 mm
<b>K3-1118</b>	240 x 240 x 100 mm

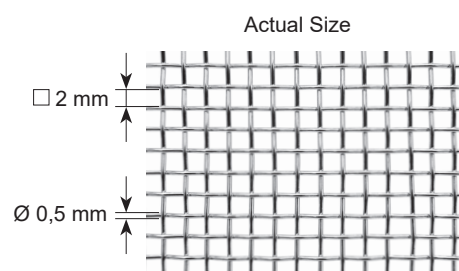
*Mesh grid*STANDARD  
MODEL

29

BIO-BARRIER  
MODEL

63

Polymer's PPSU  
Lids

97

WINDOW  
MODEL

119

 $B_{3}$   
Striker  
MODEL

139

PLASMA  
MODEL

173

A1  
MODEL

185

Dental, Mini,  
Special

205

BASKETS

223

Autolock Mechanism  
Emulating Indicator

243

ACCESSORIES

251

LAUNDRY BASKETS

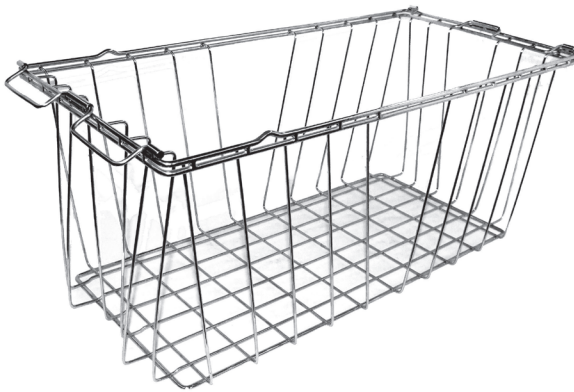

code	outside dimension
<b>K3-1080</b>	600 x 400 x 150 mm
<b>K3-1081</b>	600 x 400 x 300 mm



code	outside dimension
<b>K3-1085</b>	600 x 400 x 150 mm
<b>K3-1086</b>	600 x 400 x 300 mm

WIRE NET BASKET

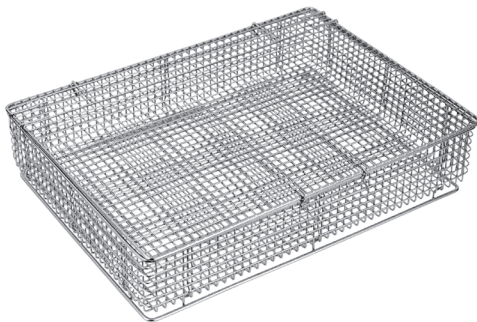

code	outside dimension
<b>K3-1200</b>	250 x 170 x 70 mm
<b>K3-1201</b>	340 x 250 x 70 mm
<b>K3-1202</b>	450 x 340 x 70 mm

LID FOR WIRE NET BASKET

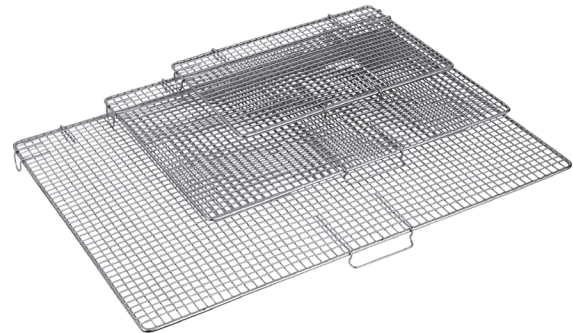

code	outside dimension
<b>K3-1203</b>	250 x 170 mm
<b>K3-1204</b>	340 x 250 mm
<b>K3-1205</b>	450 x 340 mm

STE BASKETS

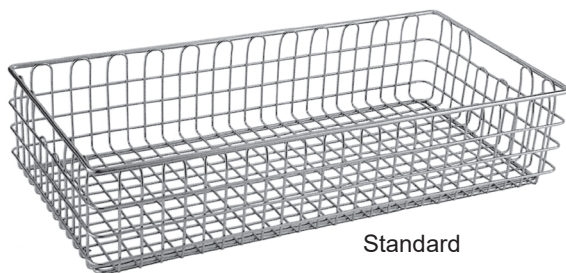

Standard

code	outside dimension
<b>K3-1206</b>	575 x 280 x 135 mm
<b>K3-1207</b>	575 x 280 x 265 mm

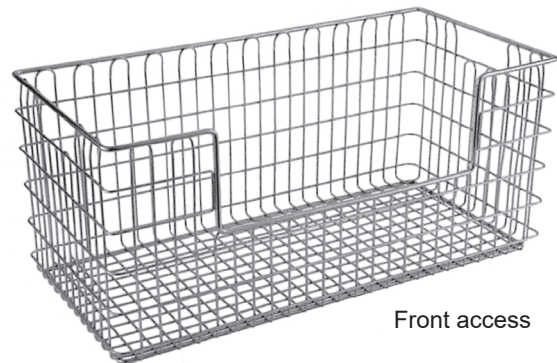

Front access

code	outside dimension
<b>K3-1208</b>	575 x 280 x 265 mm

SPRI BASKETS

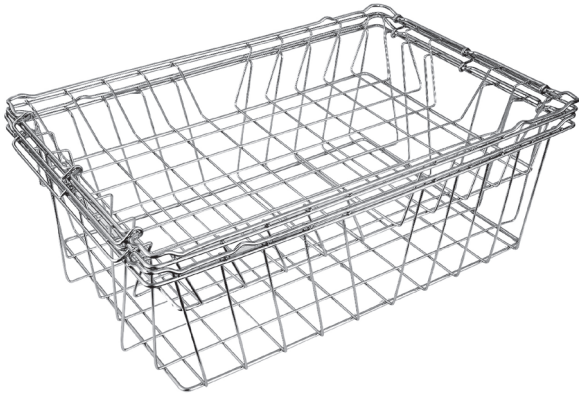

Double Frame with Folding Handle

code	outside dimension
<b>K3-1210</b>	585 x 395 x 100 mm
<b>K3-1211</b>	585 x 395 x 195 mm

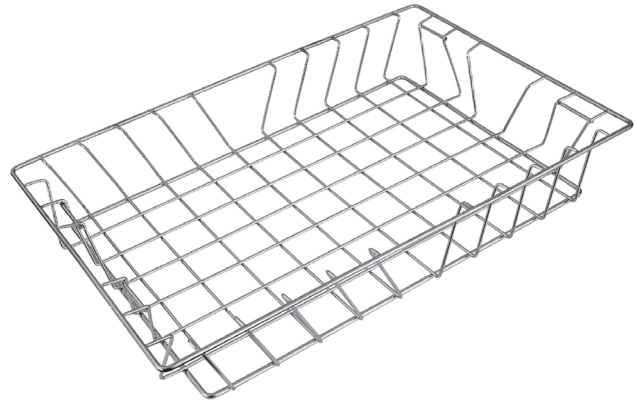

With Single Frame

code	outside dimension
<b>K3-1230</b>	600 x 300 x 40 mm
<b>K3-1231</b>	600 x 300 x 50 mm
<b>K3-1232</b>	600 x 300 x 100 mm
<b>K3-1233</b>	600 x 300 x 130 mm
<b>K3-1234</b>	600 x 300 x 150 mm
<b>K3-1235</b>	600 x 300 x 180 mm
<b>K3-1236</b>	600 x 300 x 200 mm
<b>K3-1237</b>	600 x 400 x 100 mm
<b>K3-1238</b>	600 x 400 x 130 mm
<b>K3-1239</b>	600 x 400 x 150 mm
<b>K3-1240</b>	600 x 400 x 180 mm
<b>K3-1241</b>	600 x 400 x 200 mm

STANDARD MODEL  
29

BIO-BARRIER MODEL  
63

Polymer's PPSU Lids  
97

WINDOW MODEL  
119

B<sub>3</sub> Barrier MODEL  
139

PLASMA MODEL  
173

A1 MODEL  
185

Dental, Mini, Special  
205

BASKETS  
223

Autolock Mechanism Emulating Indicator  
243

ACCESSORIES  
251

DRAPE



code	sizes	model
<b>K2-1600</b>	130 x 60 cm	
<b>K2-1601</b>	140 x 100 cm	for 1/1 Model
<b>K2-1602</b>	185 x 45 cm	
<b>K2-1603</b>	180 x 60 cm	
<b>K2-1615</b>	140 x 100 cm	for 3/4 Model
<b>K2-1630</b>	90 x 60 cm	
<b>K2-1631</b>	90 x 80 cm	for 1/2 Model
<b>K2-1632</b>	130 x 45 cm	
<b>K2-1633</b>	130 x 60 cm	
<b>K2-1640</b>	90 x 60 cm	for Flat Model
<b>K2-1641</b>	90 x 80 cm	
<b>K2-1650</b>	60 x 40 cm	for Mini Model
<b>K2-1660</b>	60 x 40 cm	
<b>K2-1661</b>	65 x 65 cm	for Dental Model
<b>K2-1662</b>	85 x 85 cm	

ENDOSCOPE BASKETS

304 ss wire mesh

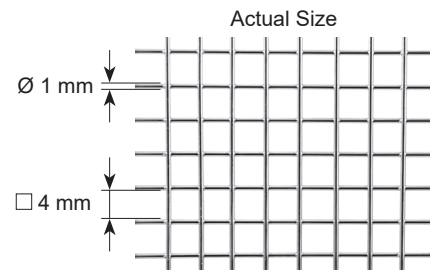

code	outside dimension
<b>K3-1050</b>	670 x 80 x 52 mm
<b>K3-1051</b>	460 x 80 x 52 mm
<b>K3-1052</b>	290 x 80 x 52 mm



code	outside dimension
<b>K3-1062</b>	640 x 150 x 77 mm



ALUMINIUM BASKET, WITH LID



code	outside dimension
<b>K3-1119</b>	245 x 130 x 55 mm



code	outside dimension
<b>K3-1120</b>	245 x 130 x 70 mm



code	outside dimension
<b>K3-1121</b>	245 x 130 x 105 mm



STANDARD  
MODEL

29

BIO-BARRIER  
MODEL

63

Polymers PPSU  
Lids

97

WINDOW  
MODEL

119

B<sub>3</sub><sup>ster</sup>  
MODEL

139

PLASMA  
MODEL

173

A1  
MODEL

185

Dental, Mini,  
Special

205

BASKETS

223

Autolock Mechanism  
Emulating Indicator

243

ACCESSORIES

251

## Washer Tube for K-WIRES

*The Aygün washer tube systems are designed in order to safely keep, healthfully wash and sterile the K-Wires used especially in orthopedic (trauma) surgery.*

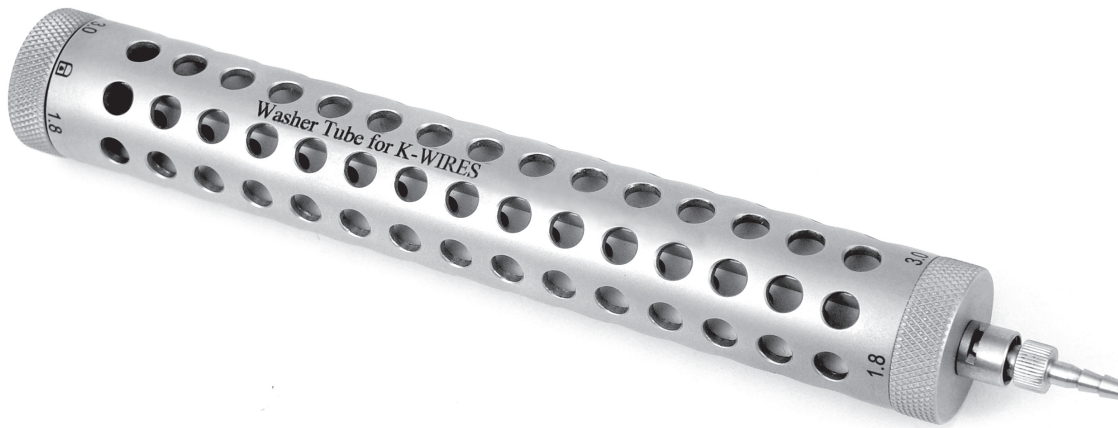

code	outside dimension
<b>K4-1051</b>	460 x 100 x 64 mm

K-Wires stainless steel basket with lid.



code	outside dimension
<b>K4-1052</b>	265 x 72 x 64 mm

K-Wires stainless steel basket with lid.

### WASHER TUBE FOR K-WIRES

The Aygün washer tube systems are designed in order to safely keep, healthfully wash and sterile the K-Wires used especially in orthopedic (trauma) surgery.

The Aygün washer tubes systems have a special design for getting maximum efficiency.

The dividing part inside the tube provides protection of 4 different diameter wires without intermixing.

With the help of inner tube placed in the middle of the divider, the high pressure water coming of the washer machine flows from inside to outside.

By this way, the wires inside the tube are washed by inside-out and outside-in flow and the disinfection process is completed efficiently.

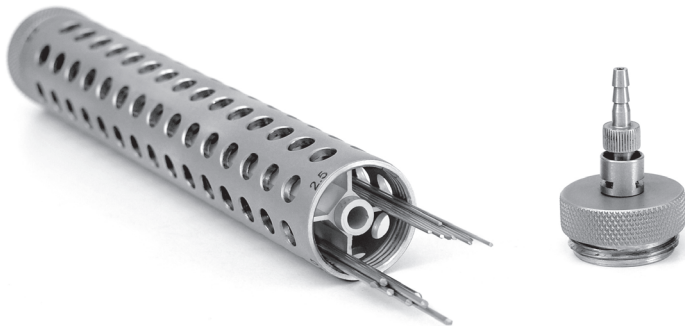
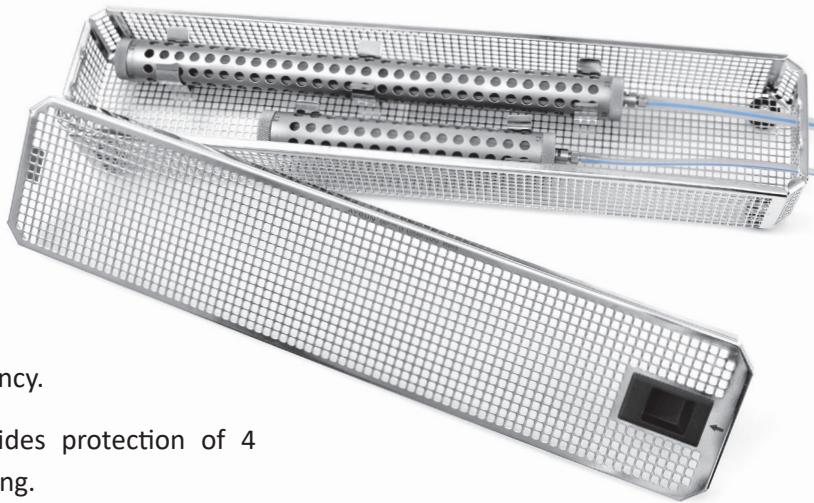

- ▶ The system has 2 different lengths as option.
- ▶ Every tube has 4 different tanks for 4 different diameter wires.
- ▶ The system has been designed suitable for 12 different diameter from 0,6 mm to 3 mm.

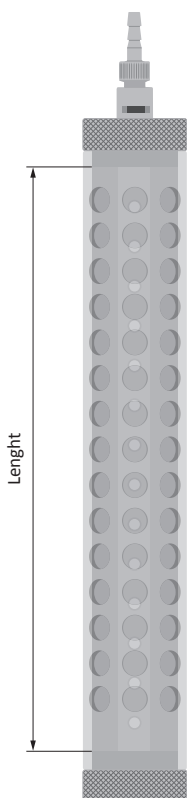

code	length	suitable wire diameters
<b>KA-100</b>	150 mm	Ø 0,60 mm Ø 0,80 mm Ø 1,00 mm Ø 1,20 mm
<b>KB-100</b>	150 mm	Ø 1,25 mm Ø 1,40 mm Ø 1,50 mm Ø 1,60 mm
<b>KC-100</b>	150 mm	Ø 1,80 mm Ø 2,00 mm Ø 2,50 mm Ø 3,00 mm
<b>KLA-100</b>	300 mm	Ø 0,60 mm Ø 0,80 mm Ø 1,00 mm Ø 1,20 mm
<b>KLB-100</b>	300 mm	Ø 1,25 mm Ø 1,40 mm Ø 1,50 mm Ø 1,60 mm
<b>KLC-100</b>	300 mm	Ø 1,80 mm Ø 2,00 mm Ø 2,50 mm Ø 3,00 mm

STANDARD MODEL 29

BIO-BARRIER MODEL 63

Polymer's PPSU Lids 97

WINDOW MODEL 119

B<sub>3</sub> Steril MODEL 139

PLASMA MODEL 173

A1 MODEL 185

Dental, Mini, Special 205

BASKETS 223

Autolock Mechanism Emulating Indicator 243

ACCESSORIES 251

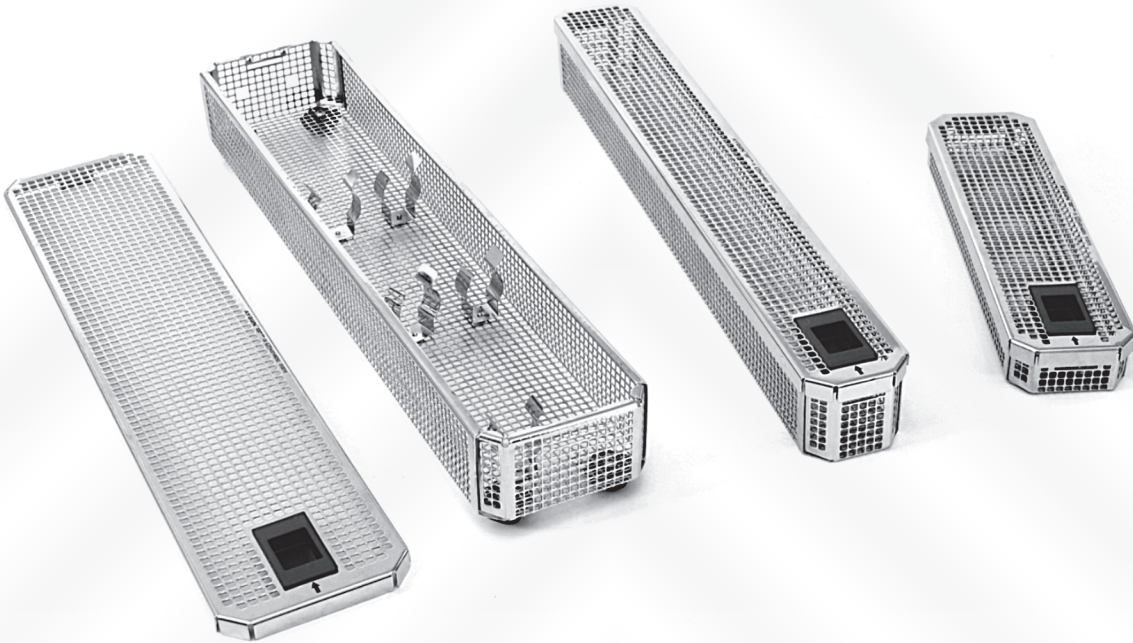

Our wire mesh and perforated sheet baskets can be manufactured in any size.

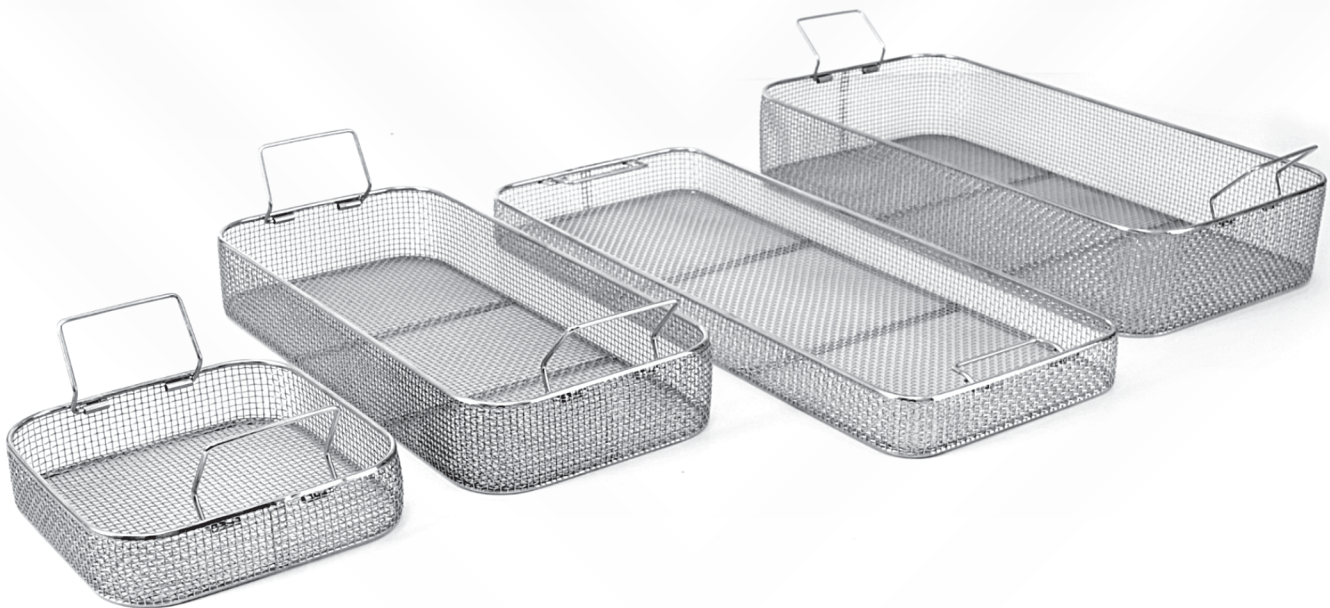

Please contact for detailed information