

31

**Knochenchirurgie**  
Bone Surgery



- ∅ 1,0 mm **31-000-10**
- ∩ 2,0 mm **31-000-20**
- ∩ 3,5 mm **31-000-35**

Citelli

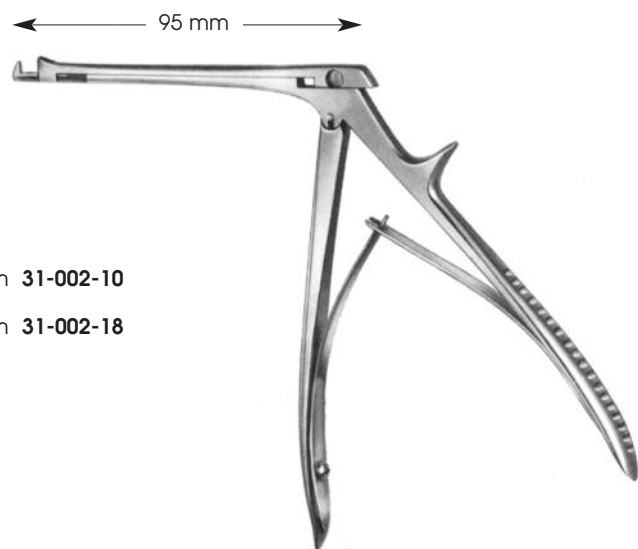

- ∅ 1,0 mm **31-002-10**
- ∩ 1,8 mm **31-002-18**

Citelli-Beyer

← 95 mm →







-  3,0 mm **31-004-03**
-  4,0 mm **31-004-04**
-  5,0 mm **31-004-05**
-  6,0 mm **31-004-06**

**Kerrison**

← 140 mm →



-  3,3 mm **31-006-33 nach oben/upwards**
-  4,0 mm **31-006-40 nach oben/upwards**
-  3,3 mm **31-007-33 nach unten/downwards**
-  4,0 mm **31-007-40 nach unten/downwards**

**Kerrison**

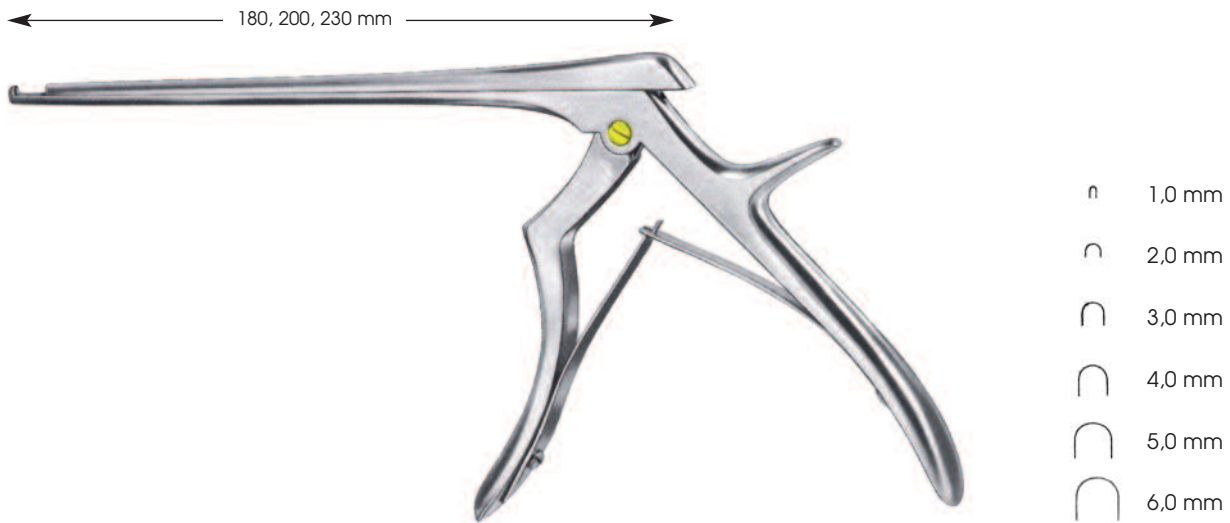

Ferris-Smith-Kerrison

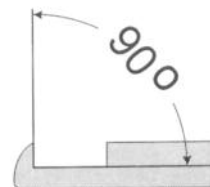
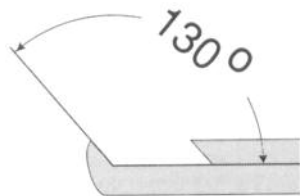

Art.-Nr. item no.	Arbeitslänge length of shaft	Schnittbreite bite	Art.-Nr. item no.	Arbeitslänge length of shaft	Schnittbreite bite
31-014-01	180 mm	1,0 mm	31-016-01	180 mm	1,0 mm
31-014-02	180 mm	2,0 mm	31-016-02	180 mm	2,0 mm
31-014-03	180 mm	3,0 mm	31-016-03	180 mm	3,0 mm
31-014-04	180 mm	4,0 mm	31-016-04	180 mm	4,0 mm
31-014-05	180 mm	5,0 mm	31-016-05	180 mm	5,0 mm
31-014-06	180 mm	6,0 mm	31-016-06	180 mm	6,0 mm
31-014-13	200 mm	3,0 mm			
31-014-14	200 mm	4,0 mm			
31-014-15	200 mm	5,0 mm			
31-014-16	200 mm	6,0 mm			
31-014-22	230 mm	2,0 mm	31-016-22	230 mm	2,0 mm
31-014-23	230 mm	3,0 mm	31-016-23	230 mm	3,0 mm
31-014-24	230 mm	4,0 mm	31-016-24	230 mm	4,0 mm
31-014-25	230 mm	5,0 mm	31-016-25	230 mm	5,0 mm

Stanzen in zerlegbarer Ausführung und mit Dünfuß auf Anfrage lieferbar.  
Punches, detachable and with thin footplate, available on request.

← 180 mm, 230 mm →



Ferris-Smith-Kerrison

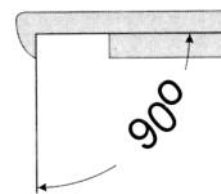
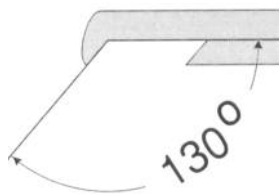

Art.-Nr. item no.	Arbeitslänge length of shaft	Schnittbreite bite
<b>31-017-01</b>	180 mm	1,0 mm
<b>31-017-02</b>	180 mm	2,0 mm
<b>31-017-03</b>	180 mm	3,0 mm
<b>31-017-04</b>	180 mm	4,0 mm
<b>31-017-05</b>	180 mm	5,0 mm
<b>31-017-22</b>	230 mm	2,0 mm
<b>31-017-23</b>	230 mm	3,0 mm
<b>31-017-24</b>	230 mm	4,0 mm
<b>31-017-25</b>	230 mm	5,0 mm

Art.-Nr. item no.	Arbeitslänge length of shaft	Schnittbreite bite
<b>31-019-01</b>	180 mm	1,0 mm
<b>31-019-02</b>	180 mm	2,0 mm
<b>31-019-03</b>	180 mm	3,0 mm
<b>31-019-04</b>	180 mm	4,0 mm
<b>31-019-05</b>	180 mm	5,0 mm
<b>31-019-22</b>	230 mm	2,0 mm
<b>31-019-23</b>	230 mm	3,0 mm
<b>31-019-24</b>	230 mm	4,0 mm
<b>31-019-25</b>	230 mm	5,0 mm

Stanzen in zerlegbarer Ausführung und mit Dünnpfuß auf Anfrage lieferbar.  
 Punches, detachable and with thin footplate, available on request.



**Syper**  
130°, 5,5 mm **31-026-55**

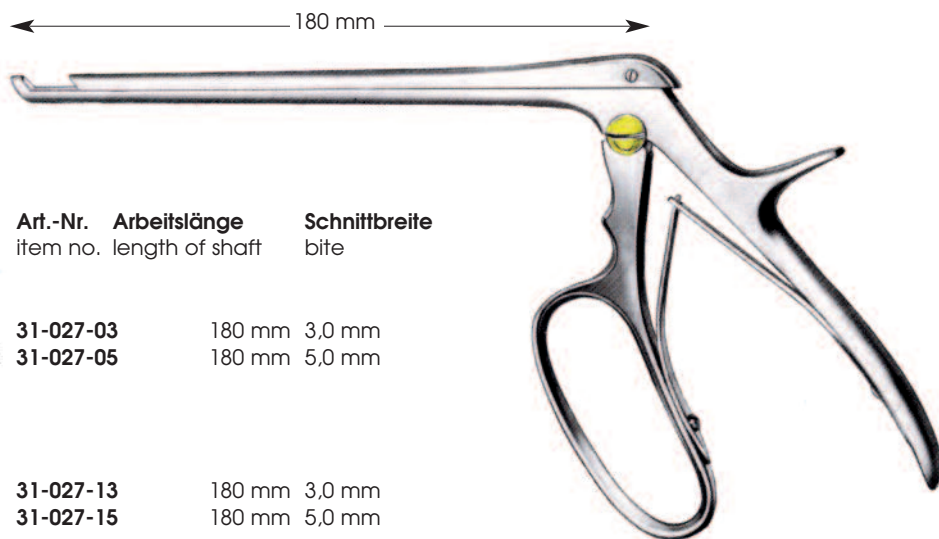

Art.-Nr. item no.	Arbeitslänge length of shaft	Schnittbreite bite
----------------------	---------------------------------	-----------------------



<b>31-027-03</b>	180 mm	3,0 mm
<b>31-027-05</b>	180 mm	5,0 mm



<b>31-027-13</b>	180 mm	3,0 mm
<b>31-027-15</b>	180 mm	5,0 mm



<b>31-027-23</b>	180 mm	3,0 mm
<b>31-027-25</b>	180 mm	5,0 mm

**Ferris-Smith-Kerrison**

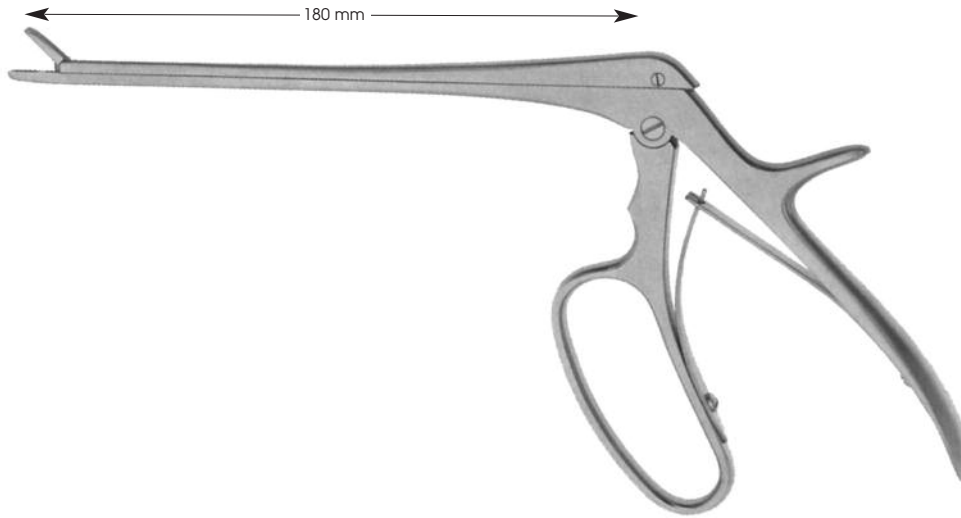

**Ferris-Smith-Cushing**

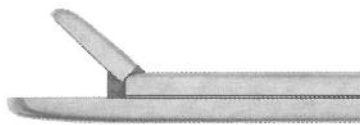

**gerade**  
 straight

- 31-028-02** 2 x 10 mm
- 31-028-03** 3 x 10 mm
- 31-028-04** 4 x 10 mm
- 31-028-05** 5 x 10 mm
- 31-028-06** 6 x 10 mm

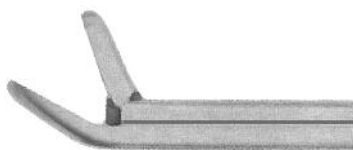

**aufgebogen**  
 curved on flat

- 31-028-12** 2 x 10 mm
- 31-028-13** 3 x 10 mm
- 31-028-14** 4 x 10 mm

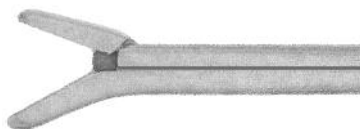

**abwärts gebogen**  
 curved down

- 31-028-22** 2 x 10 mm
- 31-028-23** 3 x 10 mm
- 31-028-24** 4 x 10 mm

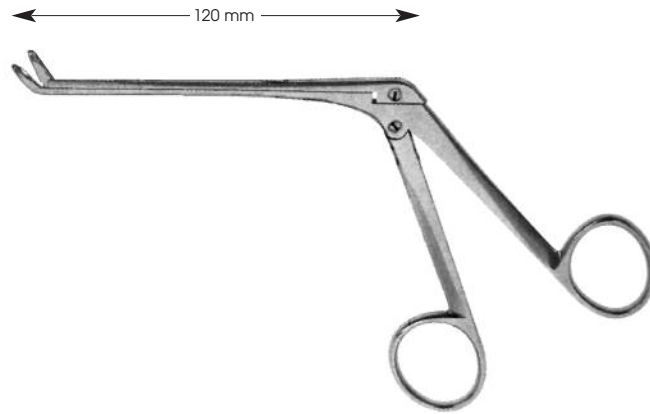

Weil-Blakesley



3,0 mm



3,6 mm



4,2 mm



4,8 mm



5,8 mm



gerade  
straight

31-036-30

31-036-36

31-036-42

31-036-48

31-036-58



45°

31-037-31

31-037-36

31-037-42

31-037-48

31-037-58



90°

31-037-66

31-037-72

31-037-78





**Myles**

 2,0 mm **31-038-02**

 3,0 mm **31-038-03**

 4,0 mm **31-038-04**



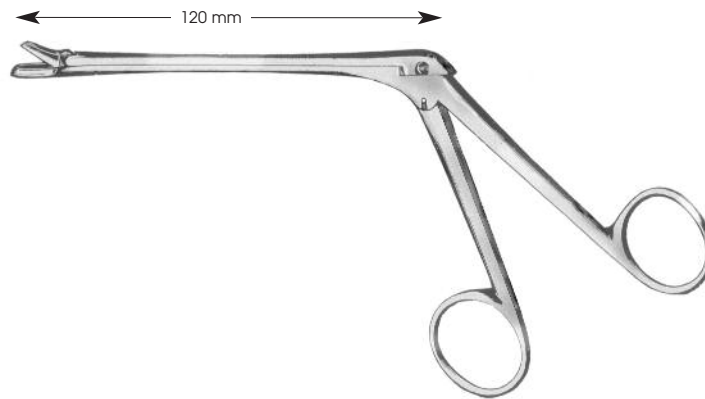

**Hajek**

 2,5 mm **31-039-25**



**Hartmann**

 5,0 mm **31-040-05**

 7,0 mm **31-040-07**

 9,0 mm **31-040-09**

 11,0 mm **31-040-11**

 13,0 mm **31-040-13**

 15,0 mm **31-040-15**

 17,0 mm **31-040-17**



**Schmeden**

 5,0 mm **31-041-12**

 7,0 mm **31-041-13**

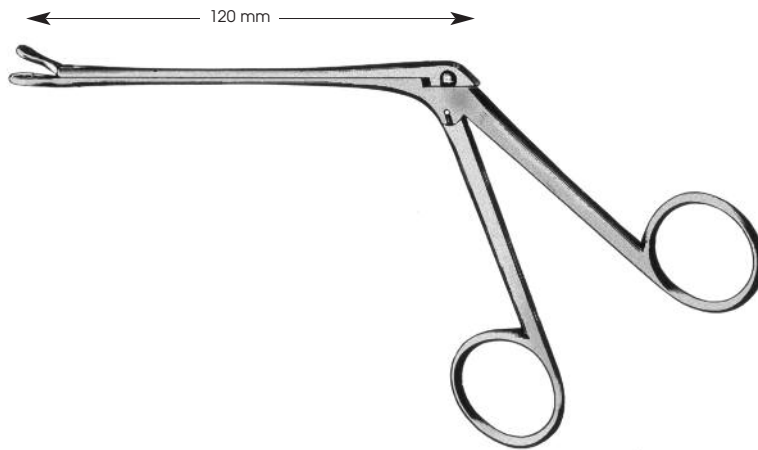

**Watson-Williams**  
31-042-01



**Weil**  
31-042-02

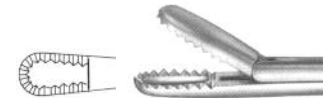

**Watson-Williams**  
31-042-03

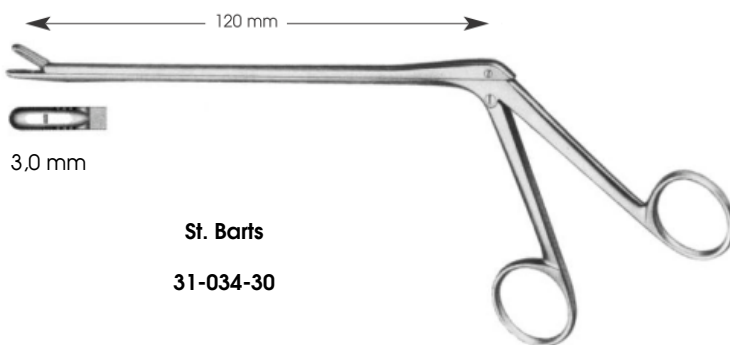

**St. Barts**  
31-034-30



31-044-03



31-045-03

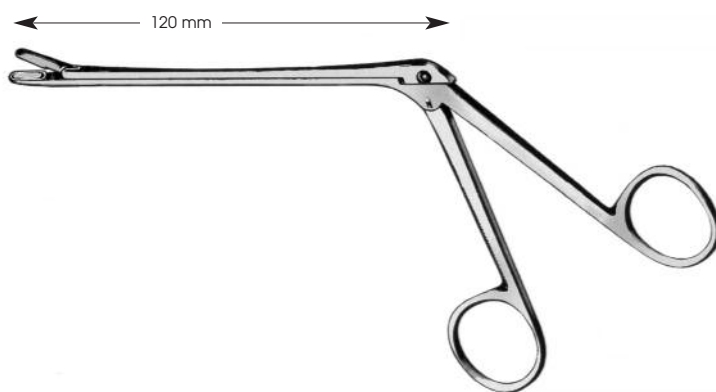

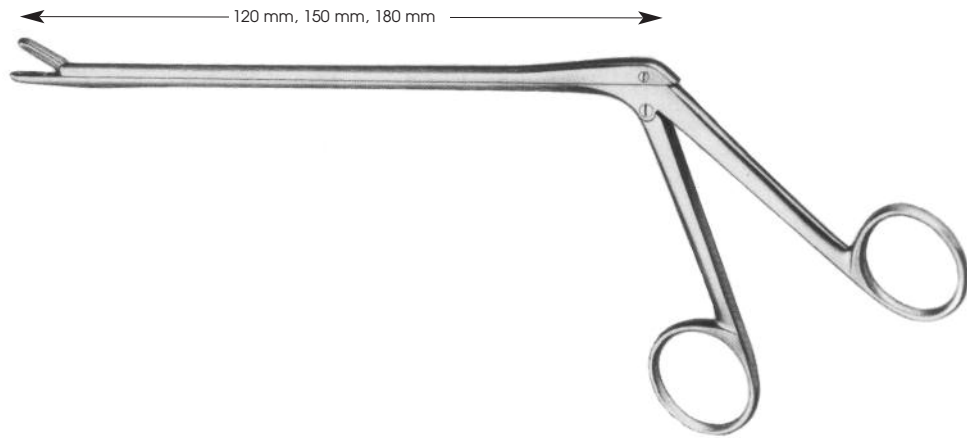

**Takahashi**

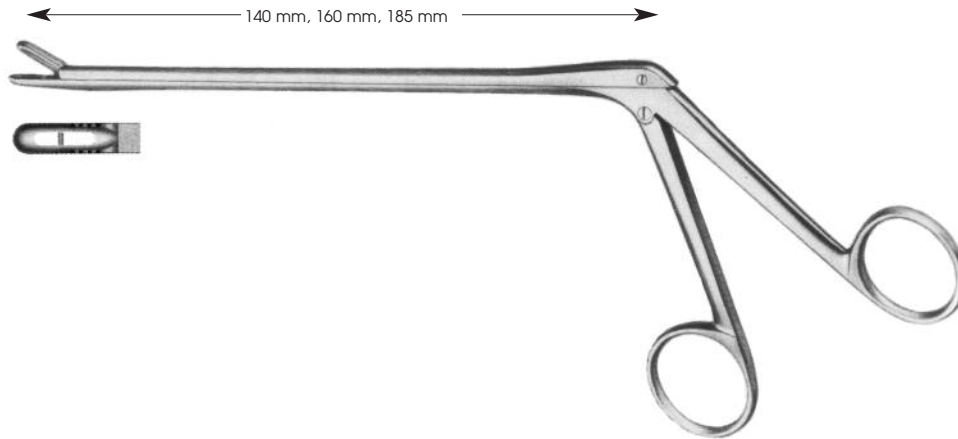

	Art.-Nr. item-no.	Bezeichnung description	Maulgröße size of jaws	Schaftlänge length of shaft
	31-046-02	Cushing	2 x 10 mm	120 mm
	31-050-02	Cushing	2 x 10 mm	150 mm
	31-066-02	Cushing	2 x 10 mm	180 mm
	31-046-03	Love Grünewald	3 x 10 mm	120 mm
	31-050-03	Love Grünewald	3 x 10 mm	150 mm
	31-066-03	Love Grünewald	3 x 10 mm	180 mm
	31-046-04	Spurling	4 x 10 mm	120 mm
	31-050-04	Spurling	4 x 10 mm	150 mm
	31-066-04	Spurling	4 x 10 mm	180 mm
	31-047-02	Cushing	2 x 10 mm	120 mm
	31-051-02	Cushing	2 x 10 mm	150 mm
	31-067-02	Cushing	2 x 10 mm	180 mm
	31-047-03	Love Grünewald	3 x 10 mm	120 mm
	31-051-03	Love Grünewald	3 x 10 mm	150 mm
	31-067-03	Love Grünewald	3 x 10 mm	180 mm
	31-047-04	Spurling	4 x 10 mm	120 mm
	31-051-04	Spurling	4 x 10 mm	150 mm
	31-067-04	Spurling	4 x 10 mm	180 mm
	31-049-02	Cushing	2 x 10 mm	120 mm
	31-053-02	Cushing	2 x 10 mm	150 mm
	31-069-02	Cushing	2 x 10 mm	180 mm
	31-049-03	Love Grünewald	3 x 10 mm	120 mm
	31-053-03	Love Grünewald	3 x 10 mm	150 mm
	31-069-03	Love Grünewald	3 x 10 mm	180 mm
	31-049-04	Spurling	4 x 10 mm	120 mm
	31-053-04	Spurling	4 x 10 mm	150 mm
	31-069-04	Spurling	4 x 10 mm	180 mm

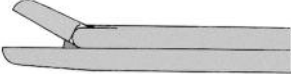

	Art.-Nr. item-no.	Bezeichnung description	Maulgröße size of jaws	Schafflänge length of shaft
	31-054-02	Caspar	2 x 12 mm	140 mm
	31-056-02	Caspar	2 x 12 mm	160 mm
	31-058-02	Caspar	2 x 12mm	185 mm
	31-054-03	Caspar	3 x 13 mm	140 mm
	31-056-03	Caspar	3 x 13 mm	160 mm
	31-058-03	Caspar	3 x 13 mm	185 mm
	31-054-04	Caspar	4 x 14 mm	140 mm
	31-056-04	Caspar	4 x 14 mm	160 mm
	31-058-04	Caspar	4 x 14 mm	185 mm
	31-054-05	Caspar	5 x 14 mm	140 mm
	31-056-05	Caspar	5 x 14 mm	160 mm
	31-058-05	Caspar	5 x 14 mm	185 mm
	31-054-06	Caspar	6 x 16 mm	140 mm
	31-056-06	Caspar	6 x 16 mm	160 mm
	31-058-06	Caspar	6 x 16 mm	185 mm
	31-055-03	Caspar	3 x 13 mm	140 mm
	31-057-03	Caspar	3 x 13 mm	160 mm
	31-059-03	Caspar	3 x 13 mm	185 mm
	31-055-04	Caspar	4 x 14 mm	140 mm
	31-057-04	Caspar	4 x 14 mm	160 mm
	31-059-04	Caspar	4 x 14 mm	185 mm
	31-055-05	Caspar	5 x 14 mm	140 mm
	31-057-05	Caspar	5 x 14 mm	160 mm
	31-059-05	Caspar	5 x 14 mm	185 mm
	31-061-03	Caspar	3 x 13 mm	140 mm
	31-063-03	Caspar	3 x 13 mm	160 mm
	31-065-03	Caspar	3 x 13 mm	185 mm
	31-061-04	Caspar	4 x 14 mm	140 mm
	31-063-04	Caspar	4 x 14 mm	160 mm
	31-065-04	Caspar	4 x 14 mm	185 mm

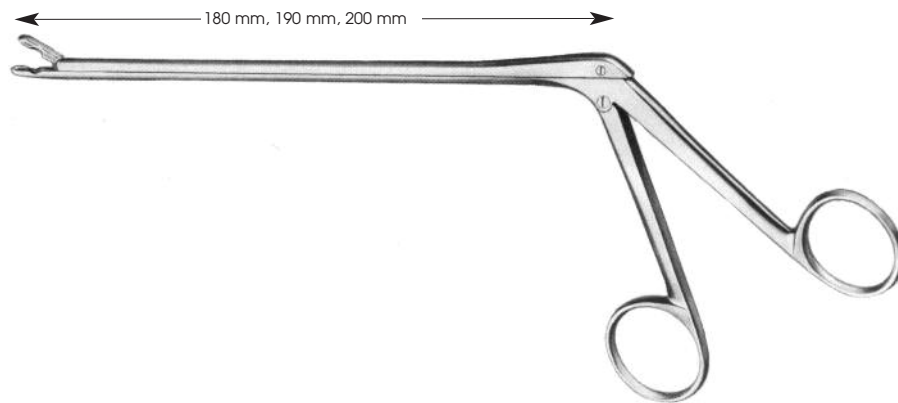

 **Oldberg**  
 18,0 cm Ø 7,0 mm **31-072-07**

 **Landolt**  
 20,0 cm Ø 9,0 mm **31-074-09**

 **Yasargil**  
 19,0 cm Ø 2,2 mm **31-076-22**

 **Yasargil**  
 19,0 cm Ø 3,5 mm **31-076-35**

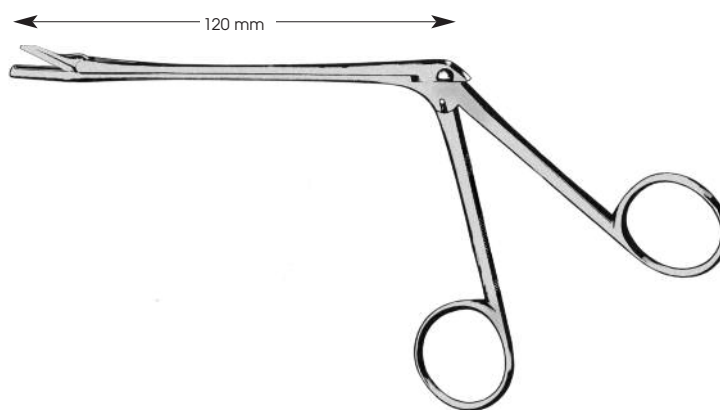

**Struycken, 12,0 cm**



**31-078-10**

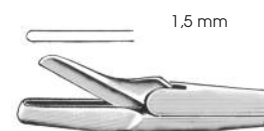

**31-078-15**

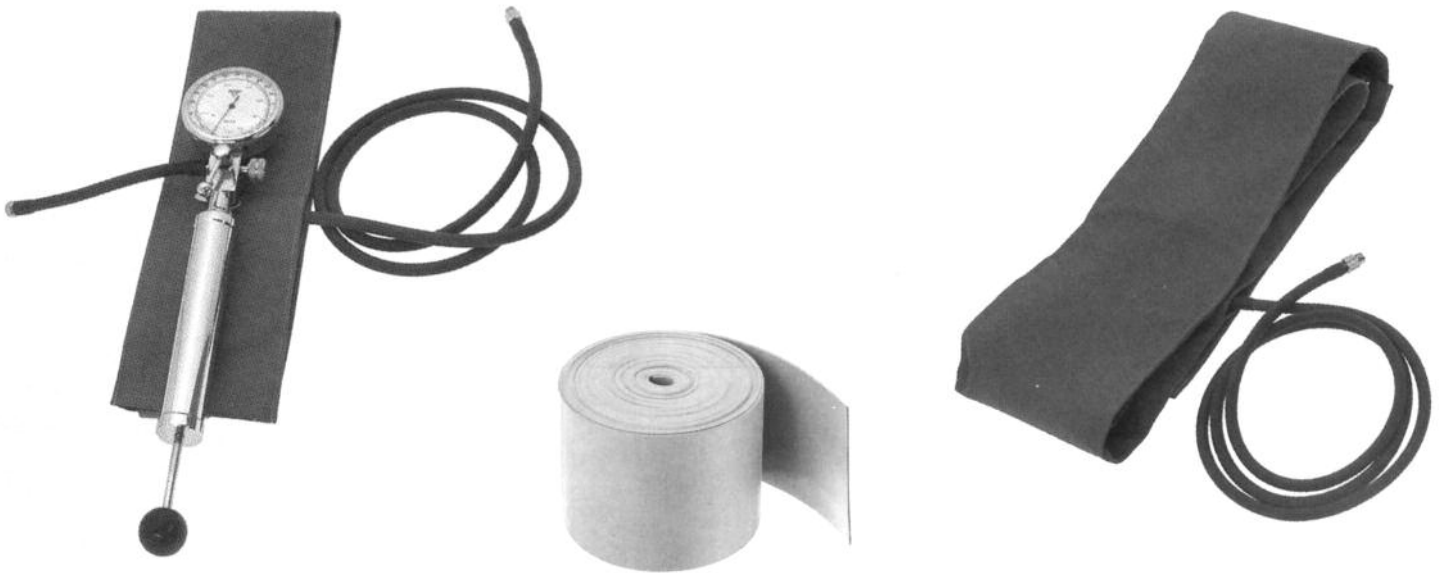

**31-110-00 Komprimeter zur Erzeugung einer Blutleere in den Gliedmaßen  
komplett bestehend aus:**

Manometer mit Membrane, Skala bis 700 mmHg,  
Stabile Pumpe,  
je 1 Oberarm- und Oberschenkelmanschette

**31-110-00 High precision instrument for causing lack of blood in the limbs.  
complete consisting of:**

Manometer with diaphragm, scale graduated to 700 mmHg,  
Resistant pump.  
1 each upper arm and upper thigh cuff

**31-110-02 Luftpumpe mit Manometer**

Pump with manometer

**31-110-03 Oberschenkel-Manschette**

Cuff for the leg

**31-110-04 Unterarm-Manschette**

Cuff for the lower arm

**31-110-10 Esmarch Staubinde 5 m**

Compression bandage, 5 m

**31-110-14 Oberarm-Manschette**

Cuff for the upper arm



Langenbeck  
31-114-55

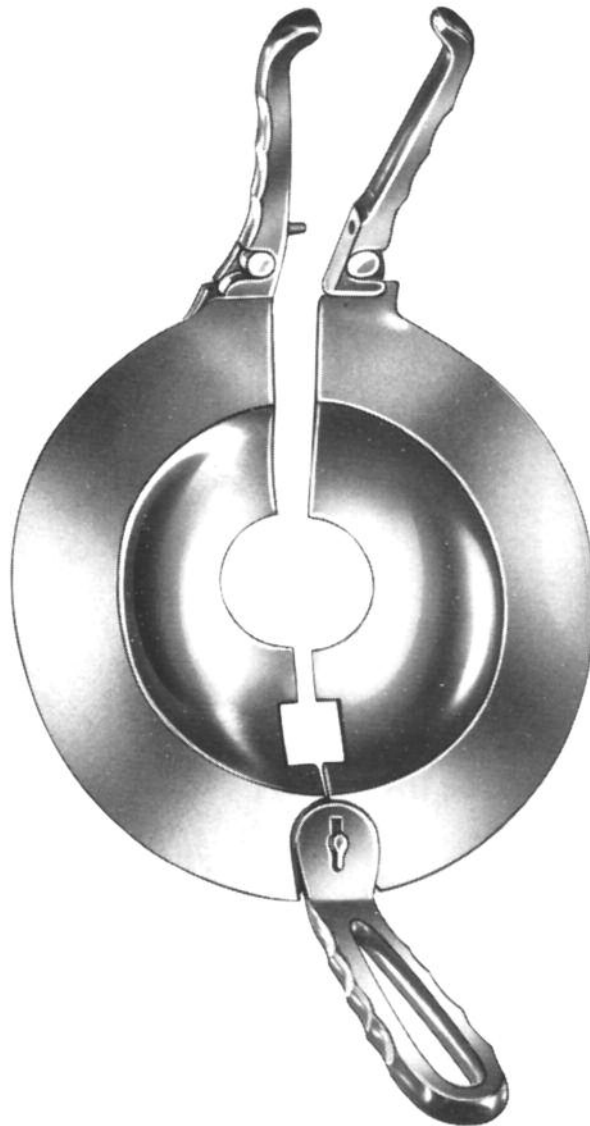

Griffe abnehmbar  
Handles detachable

Percy  
31-117-01

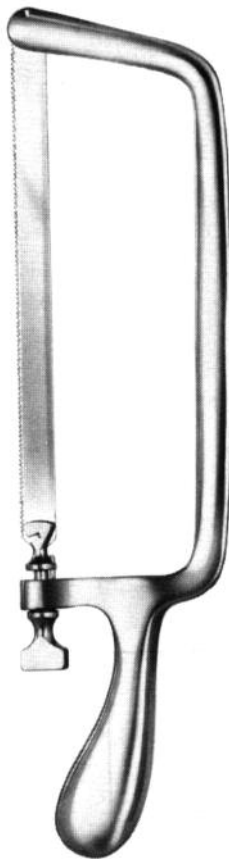

**Charrière**  
35,0 cm 31-120-00

**Ersatzsägeblätter/  
Spare saw blades**

12,0 mm 31-120-12  
15,0 mm 31-120-15  
18,0 mm 31-120-18

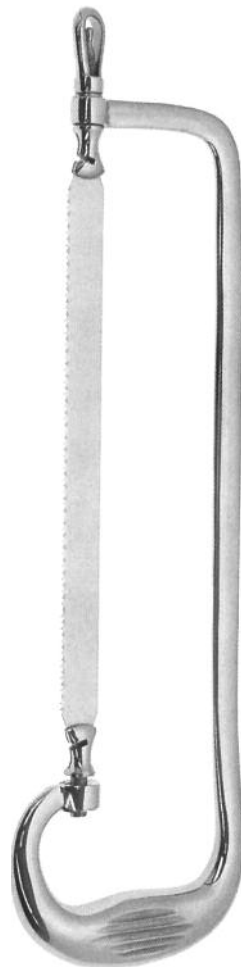

**Rust**  
39,0 cm 31-121-00

**Ersatzsägeblätter/  
Spare saw blades**

6,0 mm 31-121-06  
8,0 mm 31-121-08  
15,0 mm 31-121-15  
20,0 mm 31-121-20



**Helferich-Bier**  
42,0 cm 31-122-00

**Ersatzsägeblätter/  
Spare saw blades**

4,0 mm 31-122-04  
6,0 mm 31-122-06  
8,0 mm 31-122-08





**Charrière**  
 27,0 cm **31-124-00, Blatt 180 mm**  
 blade 180 mm

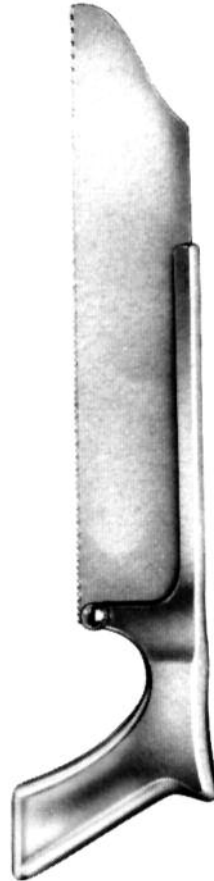

**Satterlee**  
 29,0 cm **31-126-00, Blatt 200 mm**  
 blade 200 mm



**Langenbeck**  
 23,0 cm **31-128-00, Blatt 115 mm**  
 blade 150 mm

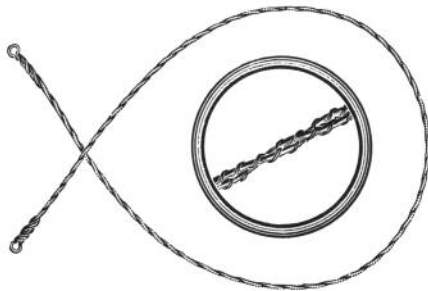

**Olivecrona**  
 30,0 cm **31-130-30**  
 40,0 cm **31-130-40**  
 50,0 cm **31-130-50**  
 60,0 cm **31-130-60**  
 70,0 cm **31-130-70**



**Gigli**  
**Griff für Drahtsägen**  
 Handle for wire saws  
**31-135-00**



**Fingerringssäge**  
Finger Ring Saw  
17,0 cm **31-137-00**

**Sägeblatt/Saw blade**  
**31-137-01**



**Fingerringssäge**  
Finger Ring Saw  
17,0 cm **31-139-00**

**Sägeblatt/Saw blade**  
**31-139-01**



**Pfriem, vierkant**  
Riemer, 4-edge  
14,0 cm **31-150-14**

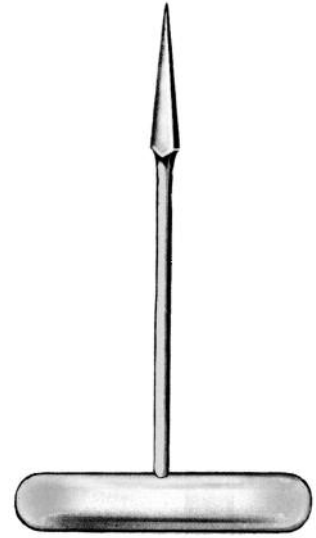

**Knochenbohrer, vierkant**  
Riemer, 4-edge  
14,0 cm **31-152-14**



**Perthes**  
**Pfriem/Riemer**  
18,0 cm **31-154-18**

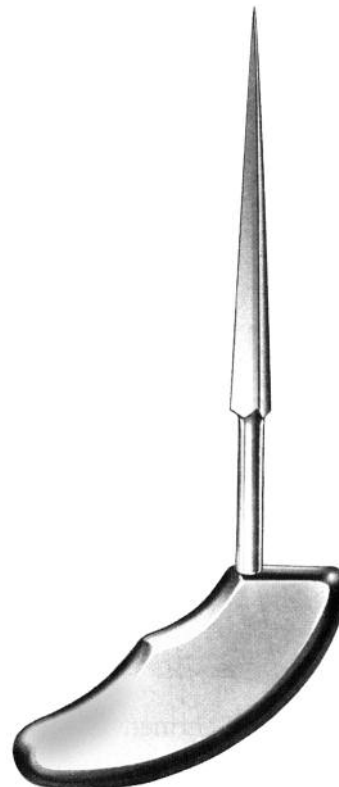

**Perthes**  
**Pfriem/Riemer**  
21,0 cm **31-156-21**

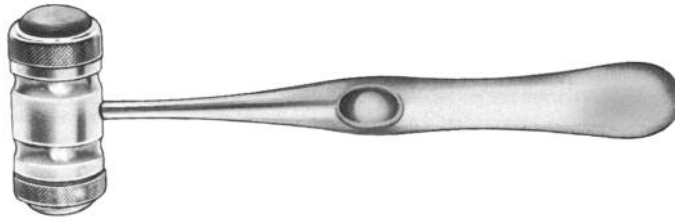

**Mead**  
 18,0 cm, Ø 20 mm, 185 g  
**31-200-20**

**Ersatzbackenpaar**  
 Spare jaws, pair  
**31-200-22**

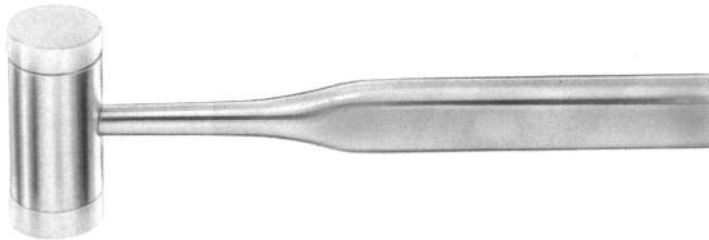

18,5 cm, Ø 25 mm, 140 g  
**31-201-25**

**Ersatzbackenpaar**  
 Spare jaws, pair  
**31-201-27**

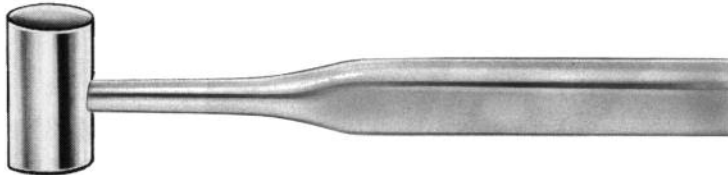

**Cottle**  
 19,0 cm, Ø 30 mm, 240 g  
**31-202-30**

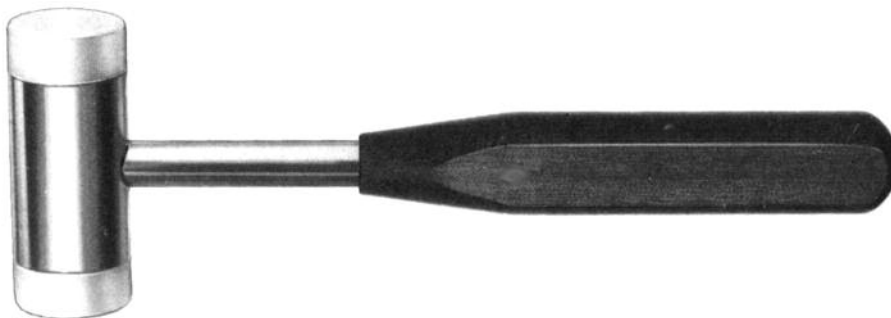

24,5 cm, Ø 30 mm, 215 g  
**31-206-30**

**Kunststoffbacken**  
 plastic disks  
**31-206-32**



**Ferrozell**  
 25,0 cm, Ø 35 mm **31-210-35**  
 25,0 cm, Ø 42 mm **31-210-42**  
 25,0 cm, Ø 50 mm **31-210-50**

**mit Bleifüllung/lead filled**  
 25,0 cm, Ø 42 mm, 400 g  
**31-224-42**



24,0 cm, Ø 32/42 mm, 400 g  
**31-212-42**

26,0 cm, Ø 30/42 mm, 530 g  
**31-228-42**

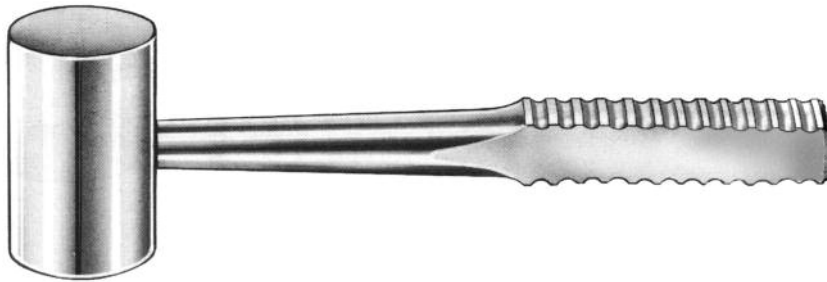

**Heath**  
18,5 cm, Ø 40 mm, 700 g  
**31-214-40**

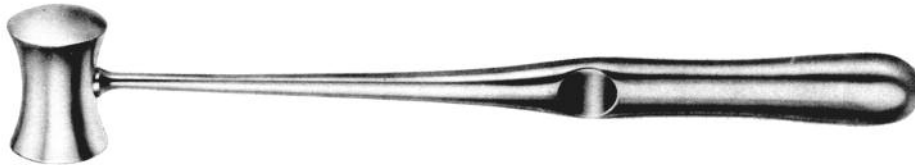

**Williger**  
24,0 cm, Ø 26 mm, 300 g **31-215-26**  
24,0 cm, Ø 28 mm, 340 g **31-215-28**  
24,0 cm, Ø 30 mm, 400 g **31-215-30**



**DOYEN**  
21,0 cm, Ø 25 mm, 120 g **31-216-25**  
21,0 cm, Ø 30 mm, 180 g **31-216-30**  
21,0 cm, Ø 35 mm, 260 g **31-216-35**

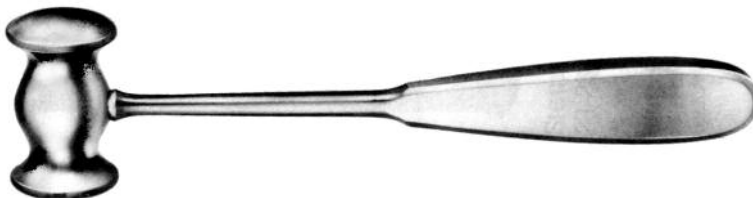

**Collin**  
20,0 cm, Ø 30 mm, 220 g  
**31-217-30**

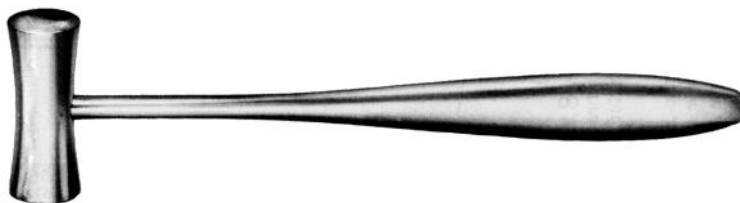

**Lucae**  
**olowiane wypelenienieg/lead filled**  
19,0 cm, Ø 19 mm, 230 g **31-218-19**  
25,0 cm, Ø 25 mm, 260 g **31-218-25**

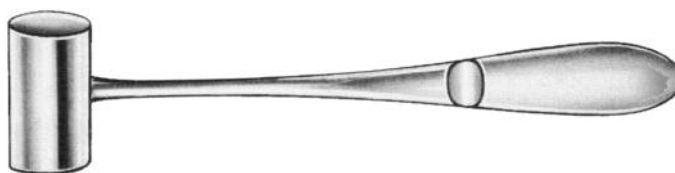

**olowiane wypelenienieg/lead filled**  
16,5 cm, Ø 22 mm, 140 g  
**31-219-20**

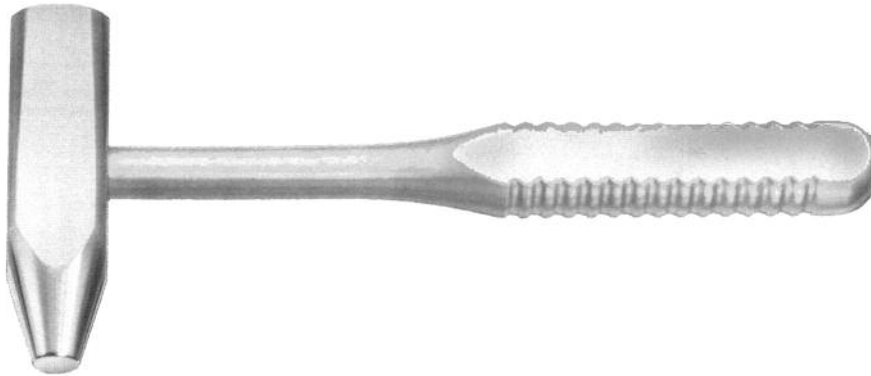

23,5 cm, 27 mm/Ø 13,5 mm  
31-220-27



26,0 cm, Ø 30 mm, 510 g  
31-221-30



**Partsch**  
18,0 cm, Ø 22 mm  
31-222-22



**Ferrozell  
mit Bleifüllung/lead filled**  
26,0 cm, Ø 42 mm, 400 g  
31-226-42



**Ferrozell**  
18,0 cm, Ø 30 mm, 125 g  
31-227-30



26,0 cm, Ø 32 mm, 675 g  
**rückschlagfrei/repercussion free**  
31-229-29

**eine Seite: Stahl konvex**  
**eine Seite: Nylon plan**  
one side: Steel convex  
one side: Nylon plane



26,0 cm, Ø 30 mm, 450 g  
**31-230-45**



26,0 cm, Ø 50 mm, 900 g  
**31-230-90**



24,0 cm, Ø 30 mm, 480 g  
**31-231-48**



**Stiel und Backen Ferrozell**  
Handle and disks of plastic  
24,0 cm, Ø 37 mm, 370 g  
**31-232-37**

**Ersatzbacken Paar**  
Spare jaws, pair  
**31-232-42**



□ 2,5 mm  
**31-250-25**  
 □ 3,5 mm  
**31-250-35**

**Passow**, 12,0 cm



● Ø 2 mm  
**31-251-02**      ● Ø 3 mm  
**31-251-02**  
 ● Ø 4 mm  
**31-251-04**      ● Ø 5 mm  
**31-251-05**  
 ● Ø 6 mm  
**31-251-06**      ● Ø 8 mm  
**31-251-08**  
 ● Ø 10 mm  
**31-251-10**

**Stößel**, 15,5 cm



**Freer**, 4 mm  
 16,0 cm **31-254-04**



**Freer**, 4 mm  
 16,0 cm **31-255-04**



□ 4 mm  
**31-262-04**      □ 6 mm  
**31-262-06**      □ 8 mm  
**31-262-08**  
 □ 10 mm  
**31-262-10**      □ 12 mm  
**31-262-12**  
 □ 14 mm  
**31-262-14**      □ 16 mm  
**31-262-16**

**Osteotom**  
 Osteotome  
 14,0 cm



□ 4 mm  
**31-263-04**      □ 6 mm  
**31-263-06**      □ 8 mm  
**31-263-08**  
 □ 10 mm  
**31-263-10**      □ 12 mm  
**31-263-12**  
 □ 14 mm  
**31-263-14**      □ 16 mm  
**31-263-16**

**Flachmeißel**  
 Chisel  
 14,0 cm

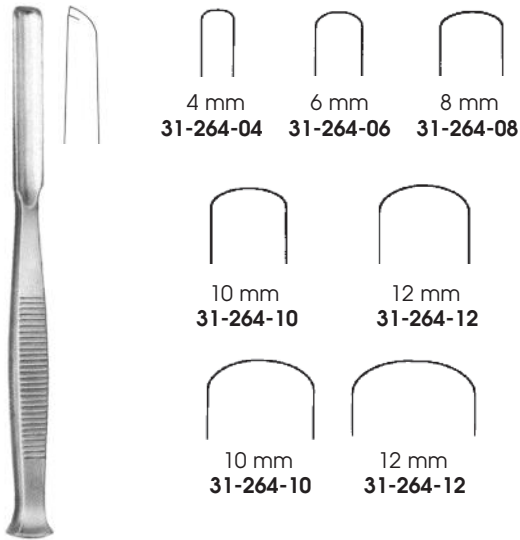

**Hohlmeißel**  
Gouge  
14,0 cm

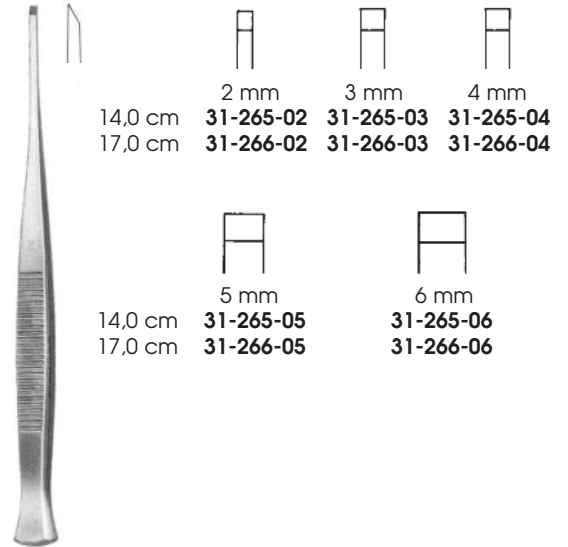

**Partsch**  
Flachmeißel/Chisel

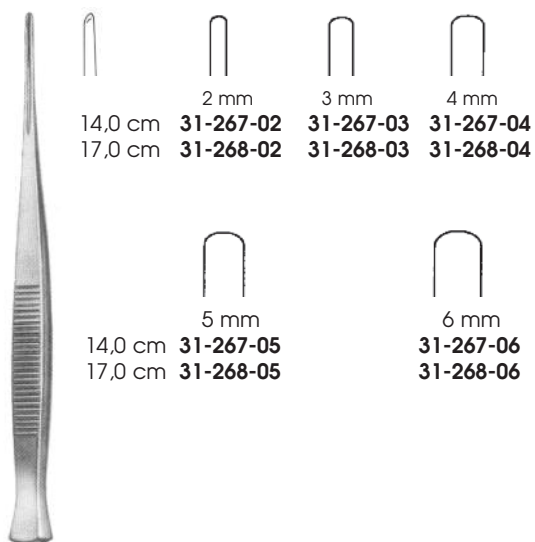

**Partsch**  
Hohlmeißel/Gouge

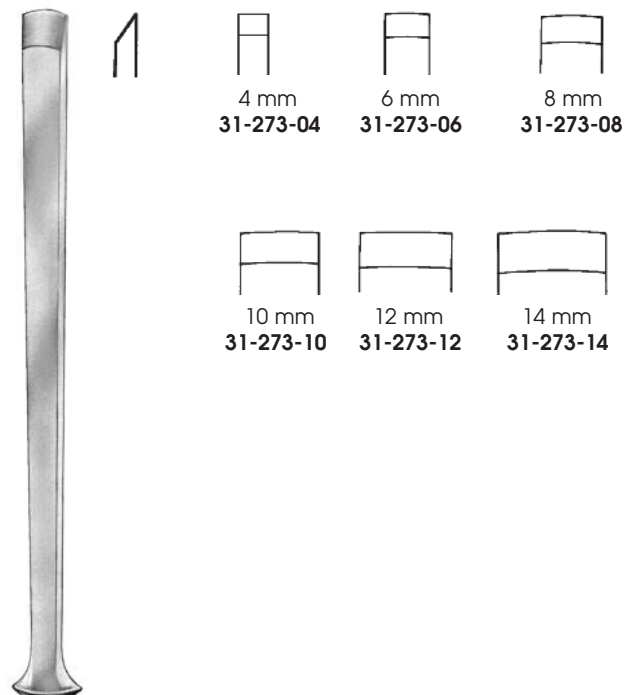

**Alexander**  
Flachmeißel/Chisel  
18,0 cm



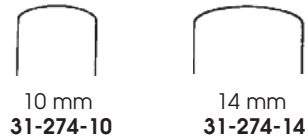

**Alexander**  
**Hohlmeißel/Gouge**  
 18,0 cm

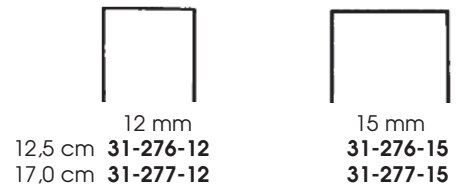
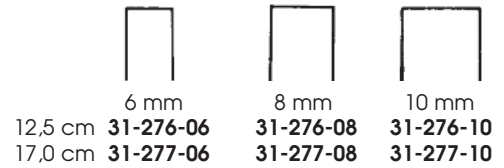
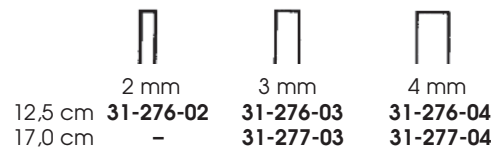

**Mini-Lambotte**  
**Osteotom/Osteotome**



**Cottle**, 18,0 cm



**Cottle**, 18,0 cm



**Fischschwanz Osteotom**  
**Fishtail Osteotome**  
 18,0 cm 31-280-08

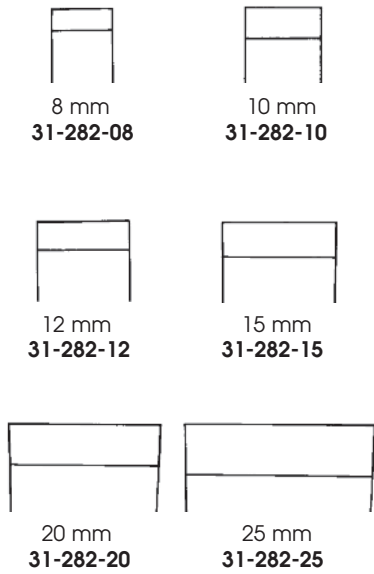



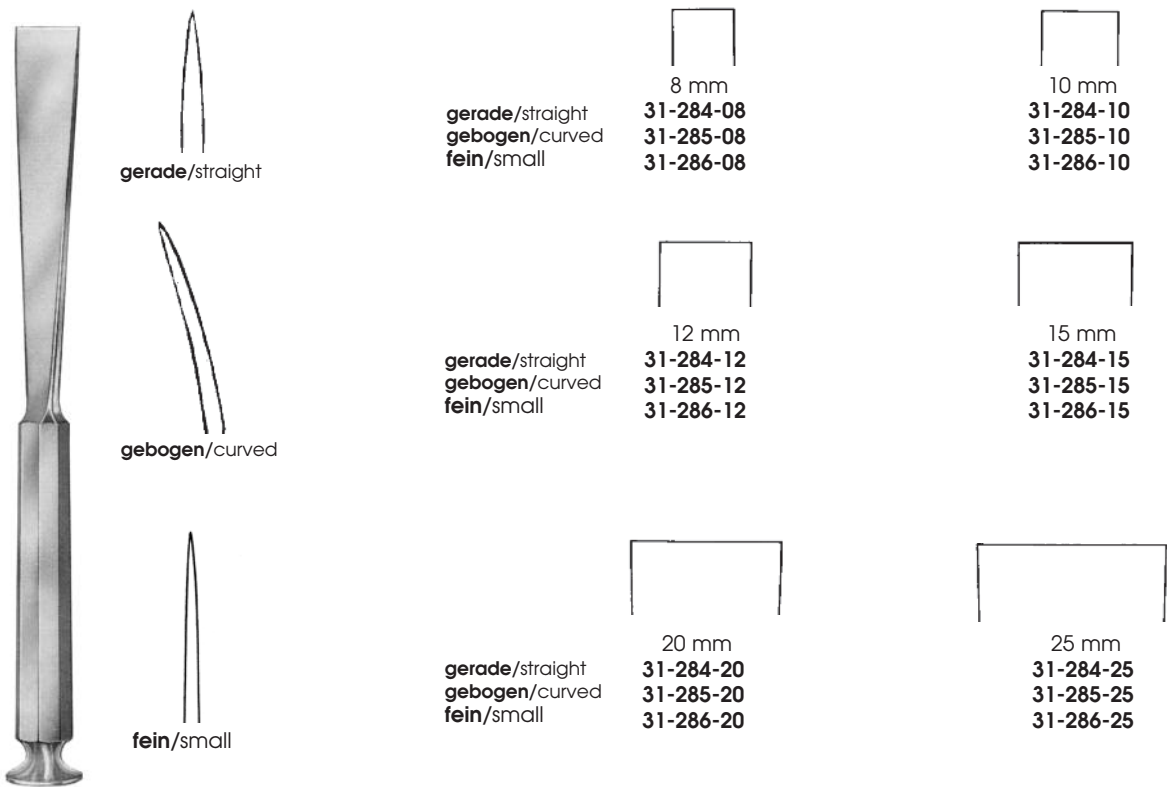



**Stille**  
**Flachmeißel/Chisel**  
20,0 cm



**Stille**  
**Osteotom/Osteotome**  
31-284-08 - 31-286-25  
20,0 cm



**Stille**  
**Hohlmeißel/Gouge**  
 20,0 cm

<b>31-288-10</b>		<b>31-289-10</b>	
<b>31-288-12</b>		<b>31-289-12</b>	
<b>31-288-15</b>		<b>31-289-15</b>	
<b>31-288-20</b>		<b>31-289-20</b>	
<b>31-288-25</b>		<b>31-289-25</b>	

	<b>31-292-04</b>
4,0 mm	<b>31-292-04</b>
5,0 mm	<b>31-292-05</b>
6,0 mm	<b>31-292-06</b>
8,0 mm	<b>31-292-08</b>
10,0 mm	<b>31-292-10</b>
13,0 mm	<b>31-292-13</b>
15,0 mm	<b>31-292-15</b>
18,0 mm	<b>31-292-18</b>
20,0 mm	<b>31-292-20</b>
25,0 mm	<b>31-292-25</b>
30,0 mm	<b>31-292-30</b>
38,0 mm	<b>31-292-38</b>
44,0 mm	<b>31-292-44</b>
50,0 mm	<b>31-292-50</b>

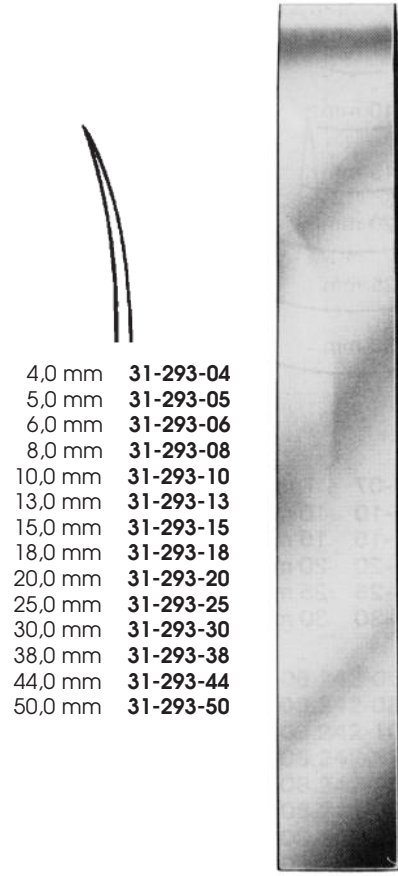
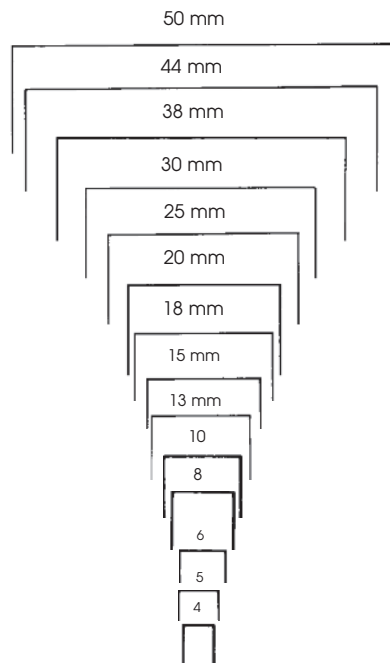

4,0 mm	<b>31-293-04</b>
5,0 mm	<b>31-293-05</b>
6,0 mm	<b>31-293-06</b>
8,0 mm	<b>31-293-08</b>
10,0 mm	<b>31-293-10</b>
13,0 mm	<b>31-293-13</b>
15,0 mm	<b>31-293-15</b>
18,0 mm	<b>31-293-18</b>
20,0 mm	<b>31-293-20</b>
25,0 mm	<b>31-293-25</b>
30,0 mm	<b>31-293-30</b>
38,0 mm	<b>31-293-38</b>
44,0 mm	<b>31-293-44</b>
50,0 mm	<b>31-293-50</b>

**Lambotte**  
**Osteotom/Osteotome**  
 24,0 cm

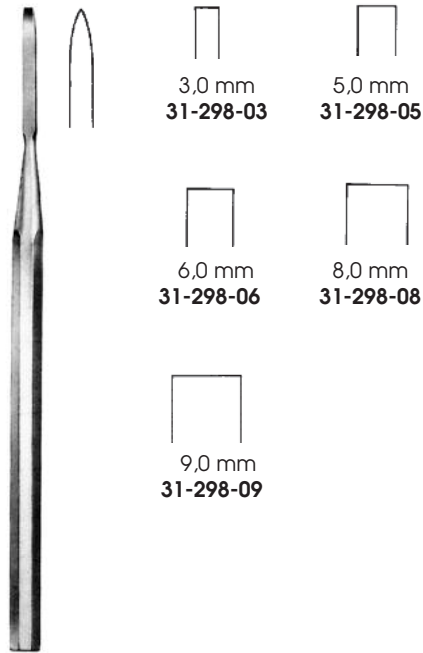

**Hoke**  
**Flachmeißel/Chisel**  
17,0 cm

3,0 mm  
**31-298-03**

5,0 mm  
**31-298-05**





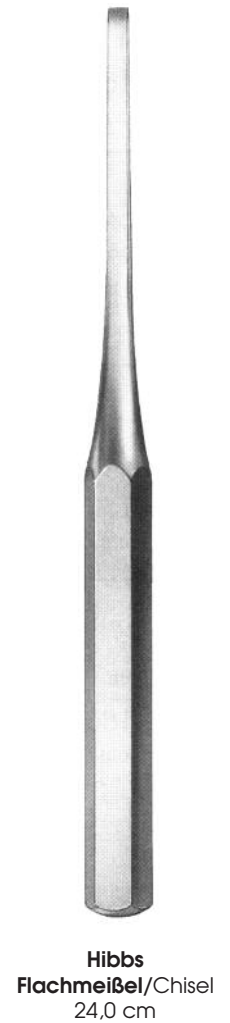
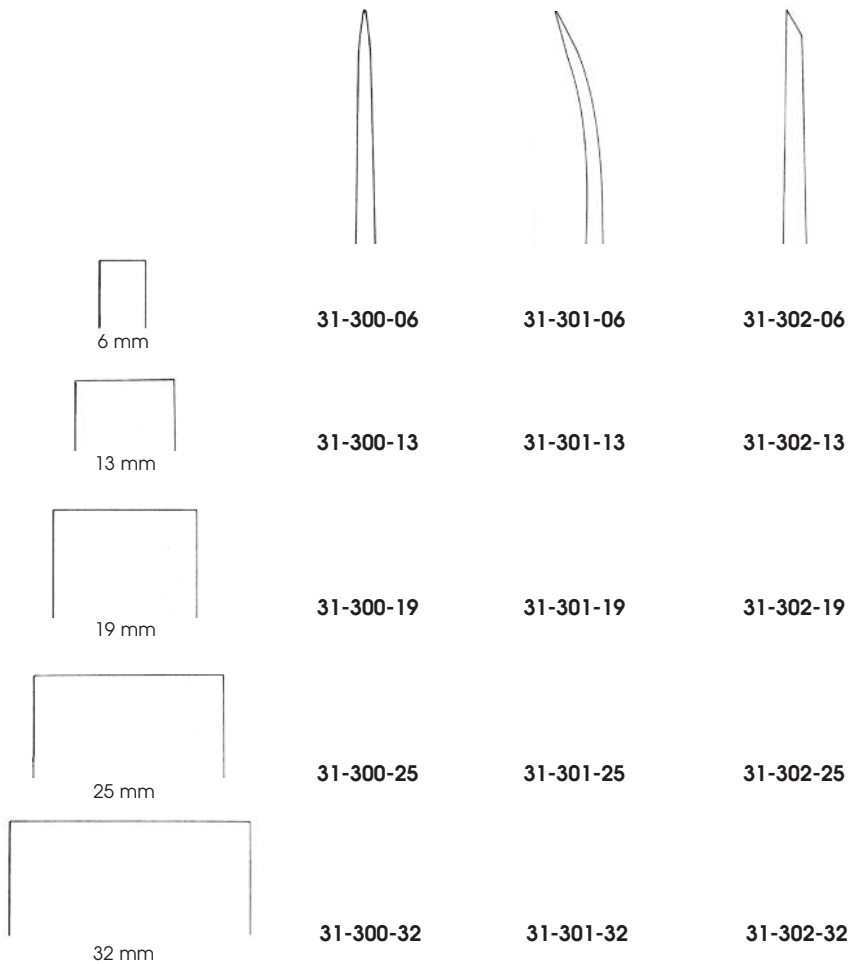

6,0 mm  
**31-298-06**

8,0 mm  
**31-298-08**

9,0 mm  
**31-298-09**



**Hibbs**  
**Flachmeißel/Chisel**  
24,0 cm

			
	6,0 mm	<b>31-303-06</b>	<b>31-304-06</b>
	13,0 mm	<b>31-303-06</b>	<b>31-304-06</b>
	19,0 mm	<b>31-303-06</b>	<b>31-304-06</b>
	25,0 mm	<b>31-303-06</b>	<b>31-304-06</b>
	32,0 mm	<b>31-303-06</b>	<b>31-304-06</b>



**Hibbs**  
**Hohlmeißel/Gouge**  
 24,0 cm



Smith-Petersen, 20,0 cm

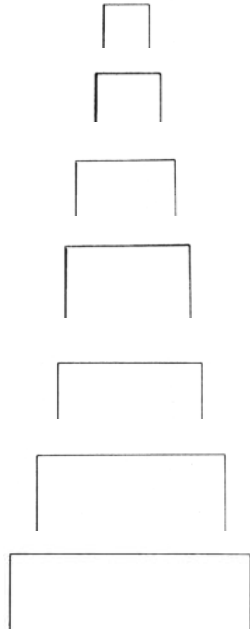

6,0 mm	<b>31-306-06</b>	<b>31-307-06</b>
9,0 mm	<b>31-306-09</b>	<b>31-307-09</b>
13,0 mm	<b>31-306-13</b>	<b>31-307-13</b>
16,0 mm	<b>31-306-16</b>	<b>31-307-16</b>
19,0 mm	<b>31-306-19</b>	<b>31-307-19</b>
25,0 mm	<b>31-306-25</b>	<b>31-307-25</b>
32,0 mm	<b>31-306-32</b>	<b>31-307-32</b>

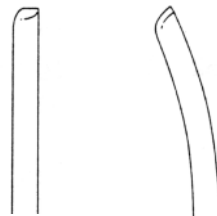

6,0 mm	<b>31-308-06</b>	<b>31-309-06</b>
9,0 mm	<b>31-308-09</b>	<b>31-309-09</b>
13,0 mm	<b>31-308-13</b>	<b>31-309-13</b>
16,0 mm	<b>31-308-16</b>	<b>31-309-16</b>
19,0 mm	<b>31-308-19</b>	<b>31-309-19</b>
25,0 mm	<b>31-308-25</b>	<b>31-309-25</b>
32,0 mm	<b>31-308-32</b>	<b>31-309-32</b>



Smith-Petersen, 20,0 cm



**Meißelgriff mit Schlüssel**  
 Handle for blades, with key  
**31-310-00**



**Wechselklingen**  
 Interchangeable blades

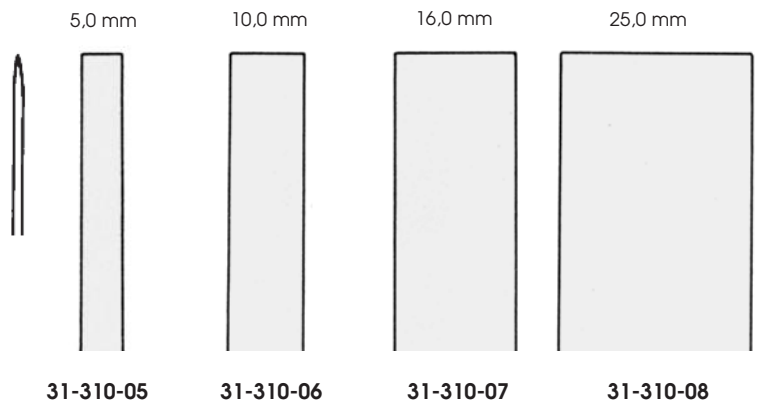
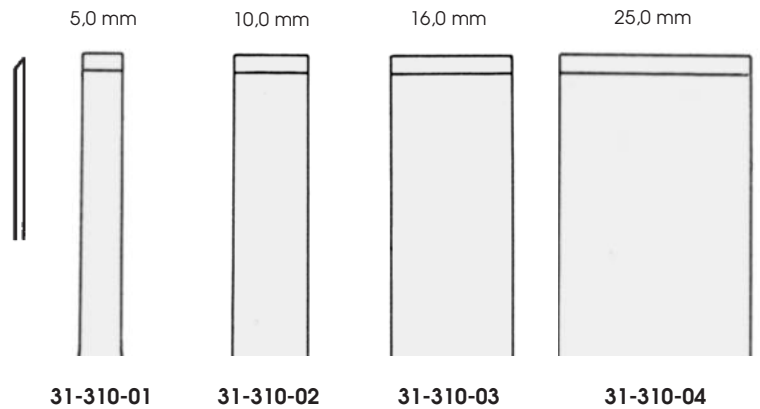

**Spannschlüssel**  
 Key  
**31-310-80**



10,0 mm **31-313-10**



10,0 mm **31-314-10**

15,0 mm **31-313-15**

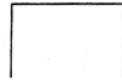

15,0 mm **31-314-15**

20,0 mm **31-313-20**

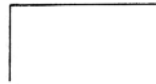

20,0 mm **31-314-20**



Osteotom, 20,0 cm

Osteotom, 20,0 cm



4,0 mm  
**31-316-04**

6,0 mm  
**31-316-06**

8,0 mm  
**31-316-08**

10,0 mm  
**31-316-10**

12,0 mm  
**31-316-12**



4,0 mm  
**31-318-04**

6,0 mm  
**31-318-06**

8,0 mm  
**31-318-08**

10,0 mm  
**31-318-10**

12,0 mm  
**31-318-12**

Lexer-Mini, 18,0 cm

Lexer-Mini, 18,0 cm





Lexer, 22,0 cm

5,0 mm **31-320-05**

7,0 mm **31-320-07**

10,0 mm **31-320-10**

15,0 mm **31-320-15**

20,0 mm **31-320-20**

25,0 mm **31-320-25**

30,0 mm **31-320-30**

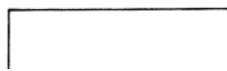
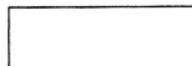
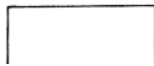
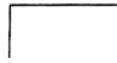

5,0 mm **31-322-05**

7,0 mm **31-322-07**

10,0 mm **31-322-10**

15,0 mm **31-322-15**

20,0 mm **31-322-20**

25,0 mm **31-322-25**

30,0 mm **31-322-30**



Lexer, 22,0 cm



Spongiosa, 25,0 cm

5,0 mm  
**31-326-05**

10,0 mm  
**31-326-100**

15,0 mm  
**31-326-15**

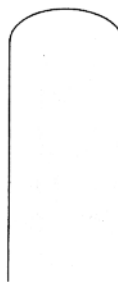

5,0 mm  
**31-327-05**

10,0 mm  
**31-327-10**

15,0 mm  
**31-327-15**



Spongiosa, 25,0 cm



Lexer-Spongiosa, 28,0 cm



7,0 mm  
31-334-07

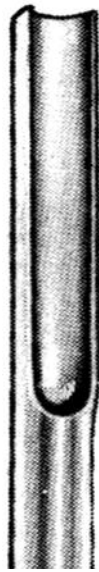

10,0 mm  
31-334-10

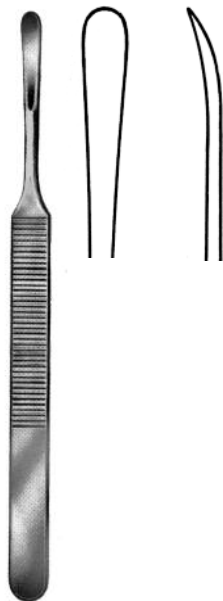

König, 5,0 mm  
15,5 cm 31-353-15

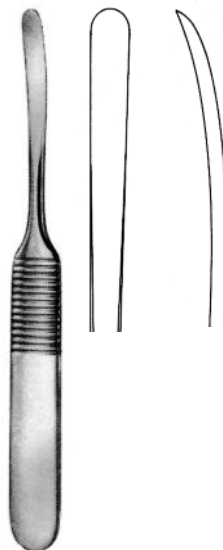

Williger, 4,2 mm  
14,0 cm 31-355-14



Williger, 6,0 mm  
16,0 cm 31-355-16

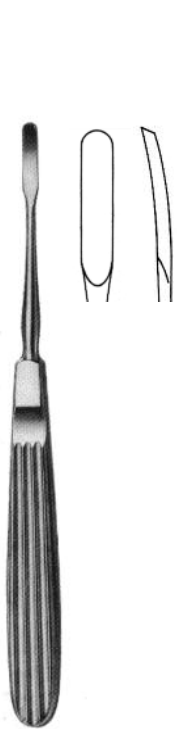

**Joseph**, 4,0 mm  
 16,0 cm **31-356-17**

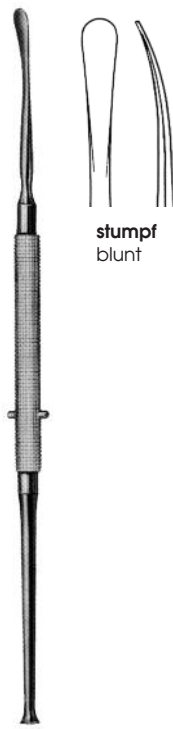

**Freer**, 4,0 mm  
 19,0 cm **31-358-19**

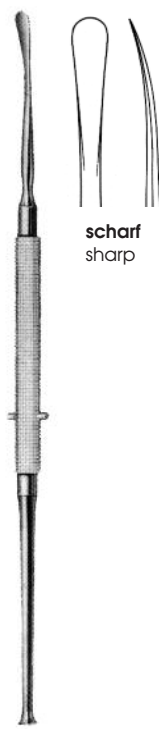

**Freer**, 4,0 mm  
 19,0 cm **31-359-19**

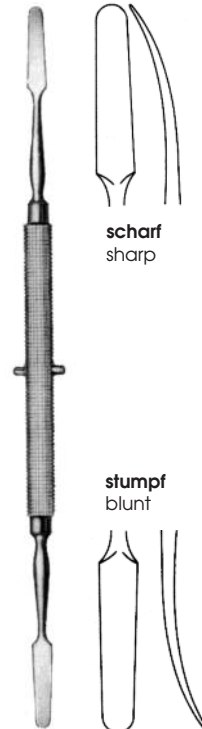

**Killian**  
 18,5 cm **31-363-18**

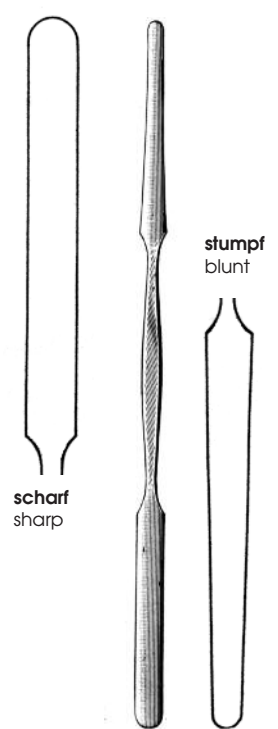

**Killian**  
 18,5 cm **31-365-18**

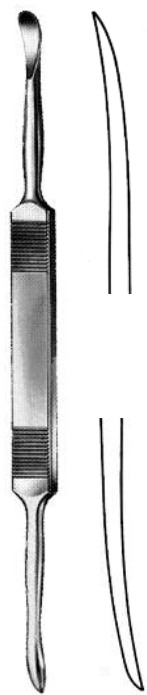

**Ohl**  
 19,0 cm **31-372-19**

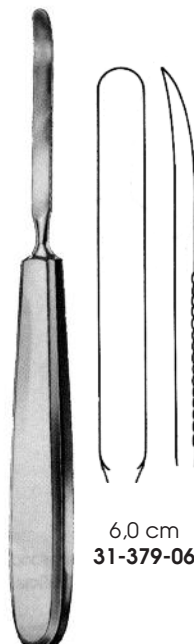

6,0 cm  
**31-379-06**

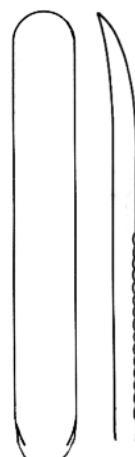

8,0 cm  
**31-379-08**



**Adson**, 17,0 cm

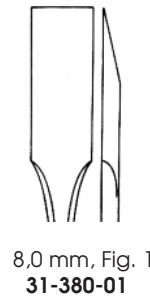

8,0 mm, Fig. 1  
**31-380-01**



7,0 mm, Fig. 2  
**31-380-02**

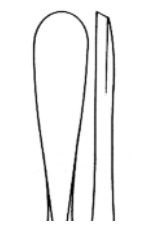

7,0 mm, Fig. 3  
**31-380-03**

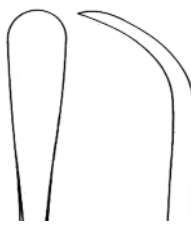

7,0 mm, Fig. 4  
**31-380-04**

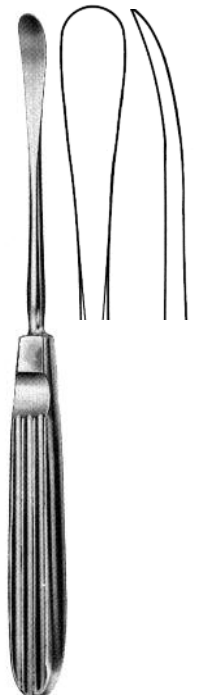

**Cottle**, 8,0 mm  
 19,5 cm **31-382-19**



19,0 cm, 6 mm  
**31-390-01**



18,5 cm, 3 mm  
**31-390-02**



19,0 cm, 6 mm  
**31-390-03**



19,0 cm, 6 mm  
**31-390-04**



18,5 cm, 13 mm  
**31-391-01**



19,5 cm, 14 mm  
**31-391-02**

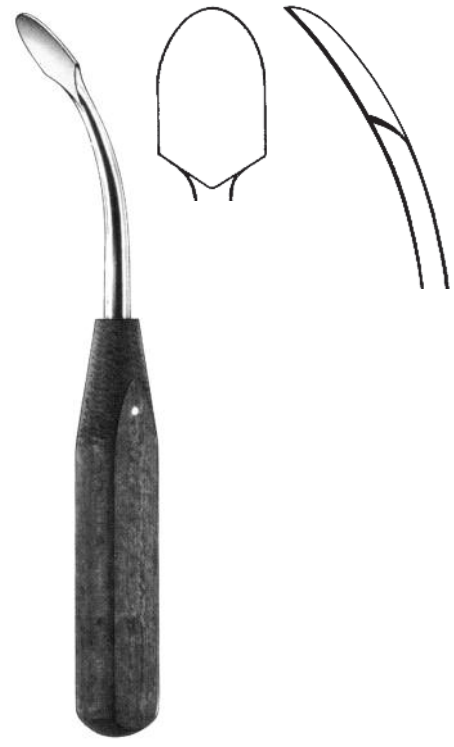

19,0 cm, 14 mm  
**31-391-03**

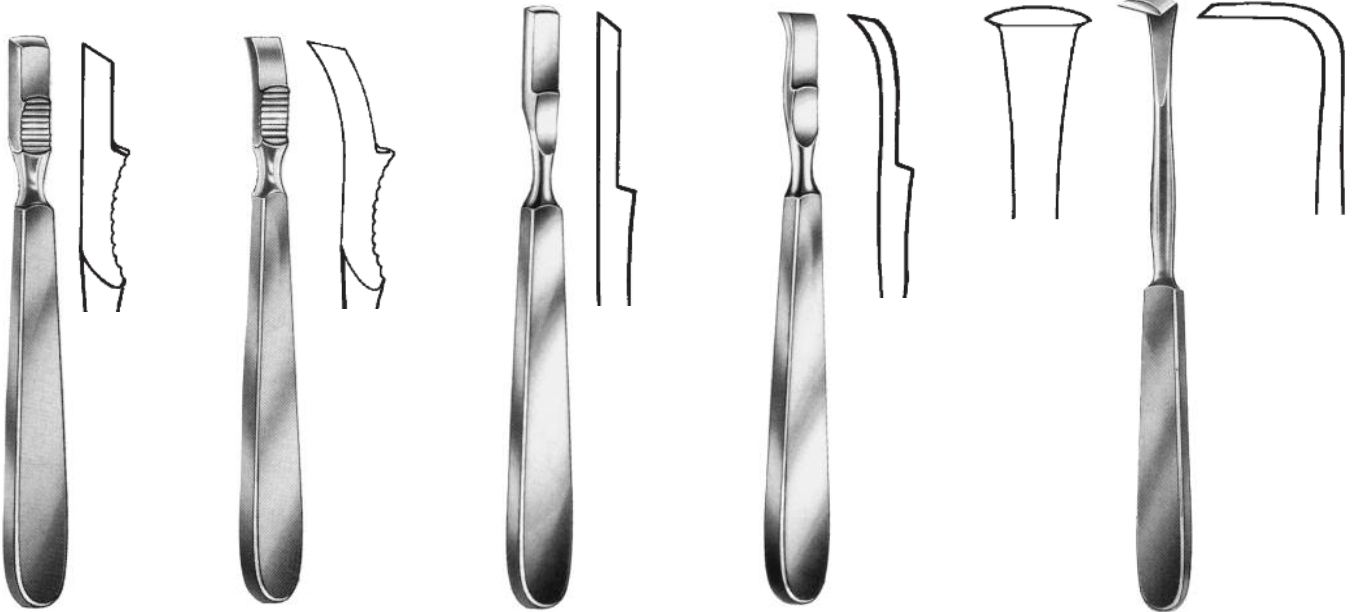

**Farabeuf, 12,5 mm**  
 15,0 cm **31-392-14**

**Farabeuf, 12,5 mm**  
 15,0 cm **31-393-14**

**Farabeuf-Collin, 11,0 mm**  
 16,0 cm **31-394-16**

**Farabeuf-Collin, 11,0 mm**  
 16,0 cm **31-395-16**

**Langenbeck, 16 mm**  
 16,5 cm **31-401-01**

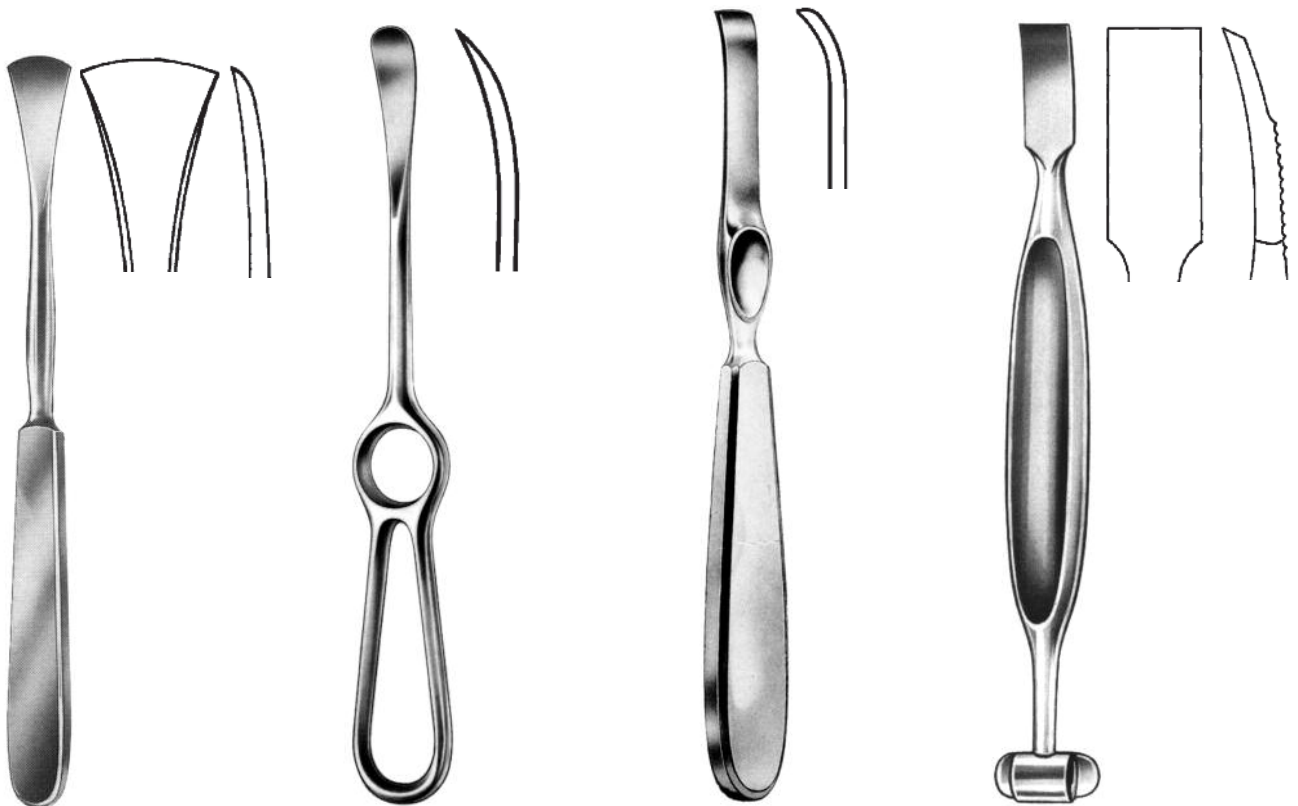

**Langenbeck, 16 mm**  
 19,0 cm **31-401-02**

**Sedillot, 14 mm**  
 21,0 cm **31-404-21**

**Lambotte, 21,5 cm**  
 5 mm **31-405-05**  
 10 mm **31-405-10**  
 15 mm **31-405-15**  
 20 mm **31-405-20**  
 25 mm **31-405-25**

**Alexander, 12 mm**  
 21,0 cm **31-406-21**



Semb



12 mm, 18 cm 31-408-01  
13 mm, 18 cm 31-408-02  
12 mm, 21 cm 31-408-03  
13 mm, 21 cm 31-408-04  
13 mm, 18 cm 31-408-05  
15 mm, 21 cm 31-408-06  
10 mm, 21 cm 31-408-07

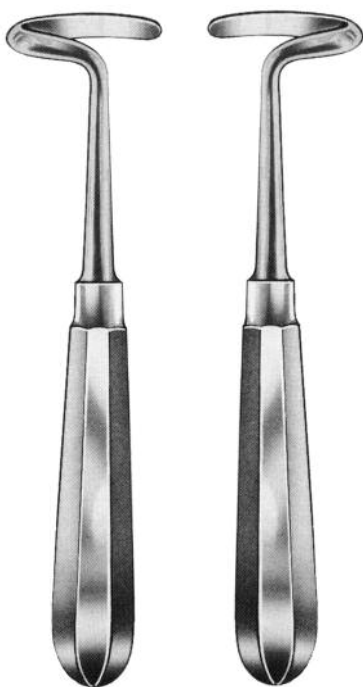

Doyen, 17,5 cm

31-409-01 - 31-409-02 Kinder/children  
31-410-01 - 31-410-02 Erwachsene/adults



31-409-01



31-409-02

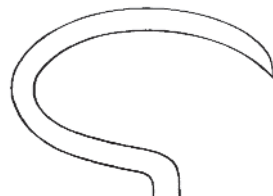

31-410-01  
31-411-01

links gebogen  
left curved



31-410-02  
31-411-02

rechts gebogen  
right curved



Doyen, 24,0 cm

31-411-01 - 31-411-02



Langenbeck



16 mm, 19 cm  
**31-412-01**

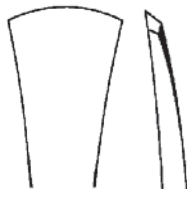

16 mm, 19 cm  
**31-412-02**

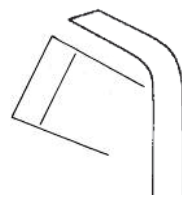

12 mm, 19 cm  
**31-412-03**

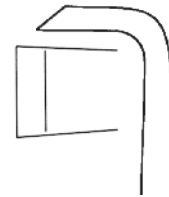

12 mm, 18 cm  
**31-412-04**



Hoehn



7 mm, 16 cm  
**31-412-10**



15 mm, 18,5 cm  
**31-412-11**



20 mm, 19 cm  
**31-412-23**



Cushing



4 mm, 17 cm  
**31-412-20**



6 mm, 17 cm  
**31-412-21**



5 mm, 19,5 cm  
**31-412-25**



7 mm, 19,5 cm  
**31-412-26**

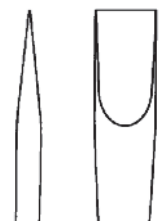

8 mm, 17 cm  
**31-412-30**

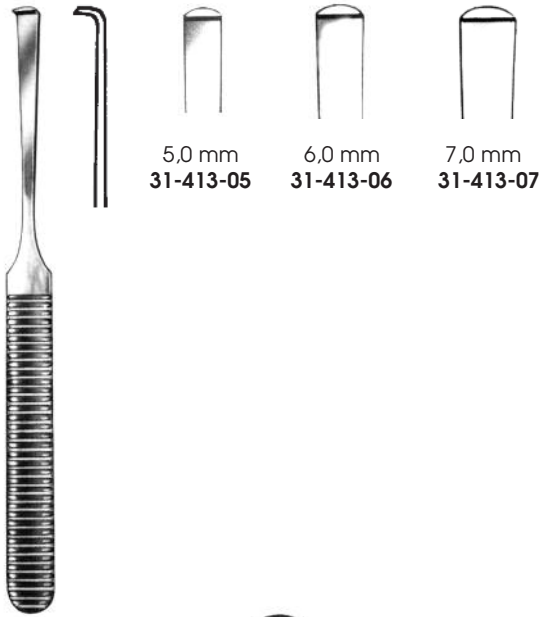

Raspatorium, 16,0 cm

5,0 mm  
31-413-05

6,0 mm  
31-413-06

7,0 mm  
31-413-07

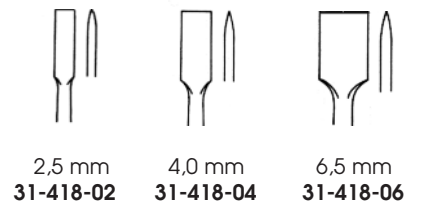

Obwegeser, 15,0 cm

2,5 mm  
31-418-02

4,0 mm  
31-418-04

6,5 mm  
31-418-06



Raspatorium  
27,5 cm 31-415-27 20 mm



Raspatorium  
33,0 cm 31-416-01 8 mm  
33,0 cm 31-416-02 17 mm



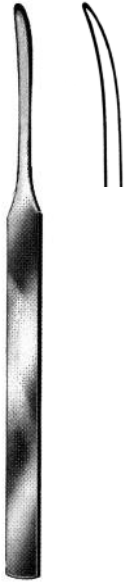

**König**, 4,5 mm
   
 15,5 cm **31-420-01**



**König**, 4,5 mm
   
 15,5 cm **31-420-02**

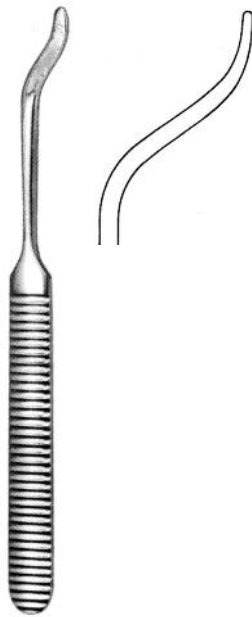

5,5 mm
   
 15,5 cm **31-421-16**



**Williger**



16,5 cm, 5,0 mm
   
**31-422-01**



17,0 cm, 5,5 mm
   
**31-422-02**

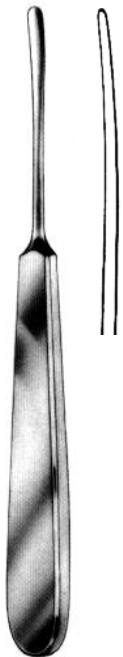

**Sebileau**, 5,0 mm
   
 17,5 cm **31-423-01**

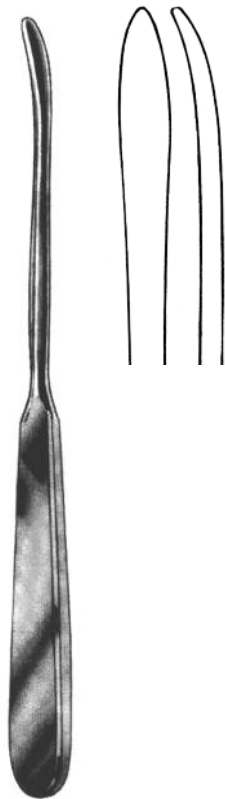

**Quervain**, 6,0 mm
   
 20,0 cm **31-423-02**



**Langenbeck**



19,5 cm, 8,0 mm
   
**31-423-03**



19,5 cm, 10,0 mm
   
**31-423-04**

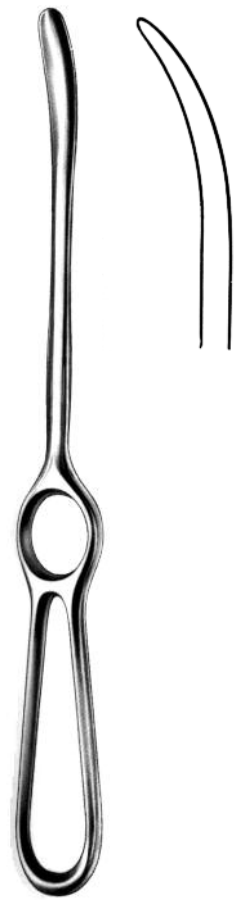

**Langenbeck**, 11,0 mm
   
 23,0 cm **31-423-05**



Martin-Langenbeck



17,0 cm, 5,0 mm  
**31-423-15**



17,0 cm, 7,0 mm  
**31-423-17**

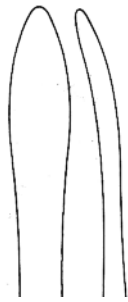

17,0 cm, 8,0 mm  
**31-423-18**

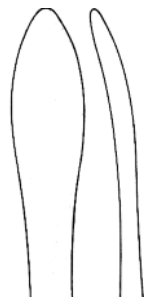

20,0 cm, 10,0 mm  
**31-423-19**



2,8 mm  
14,0 cm **31-424-01**

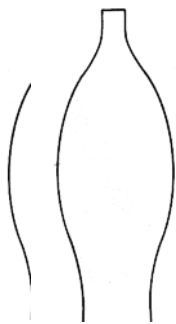

15,0 cm  
4,5 mm **31-424-0**



6,0 mm  
**31-424-03**



2/6 mm  
16,0 cm **31-425-02**

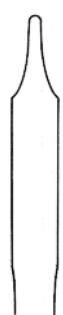

2/8 mm  
**31-425-03**



2/15 mm  
12,5 cm **31-425-04**

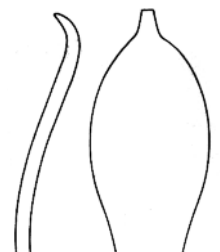



**Hohmann, 10 mm**  
22,0 cm **31-428-01**

**Hohmann, 17 mm**  
24,0 cm **31-428-02**

**Hohmann, 44 mm**  
24,0 cm **31-428-03**

**Hohmann, 65 mm**  
25,5 cm **31-428-04**



**Hohmann, 43 mm**  
25,0 cm **31-428-05**

**Hohmann, 24 mm**  
26,0 cm **31-428-06**

**Hohmann, 34 mm**  
28,5 cm **31-428-07**

**Hohmann, 25 mm**  
26,0 cm **31-428-08**

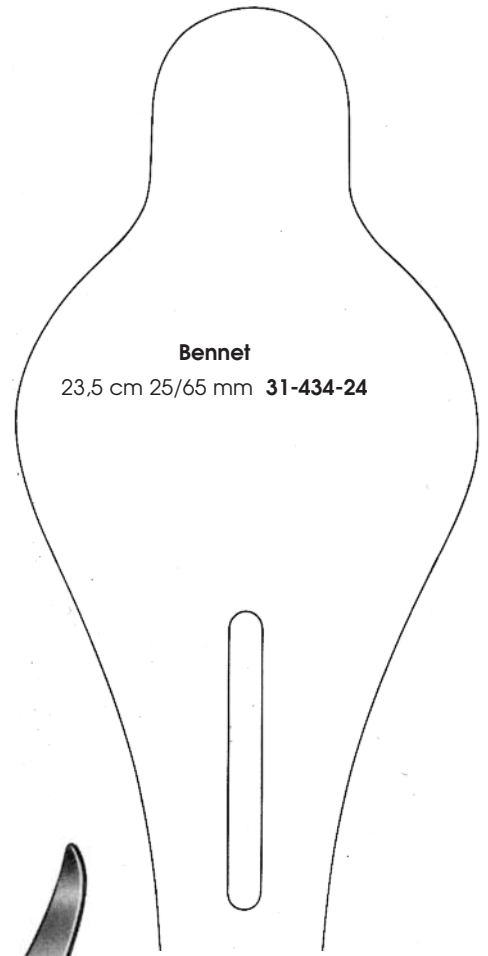
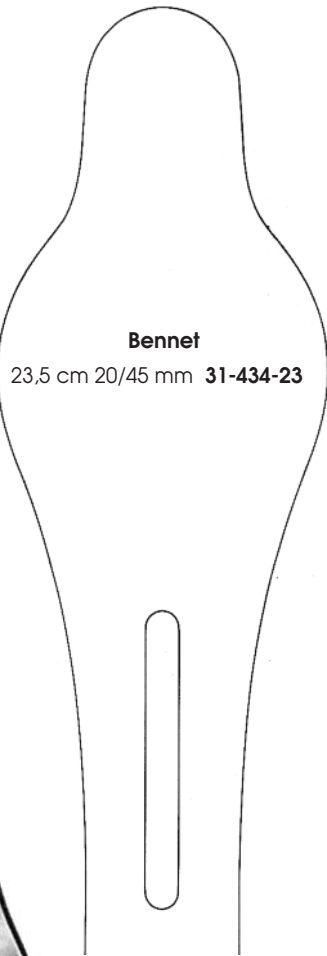

**Blount**, 38,0 mm  
26,0 cm **31-436-26**

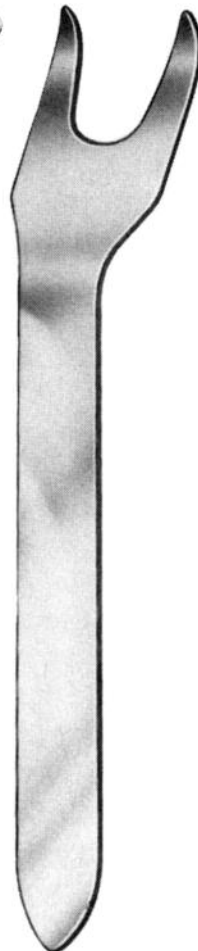

**Blount, 2-zinkig**, 38,0 mm  
26,0 cm, **31-437-26**

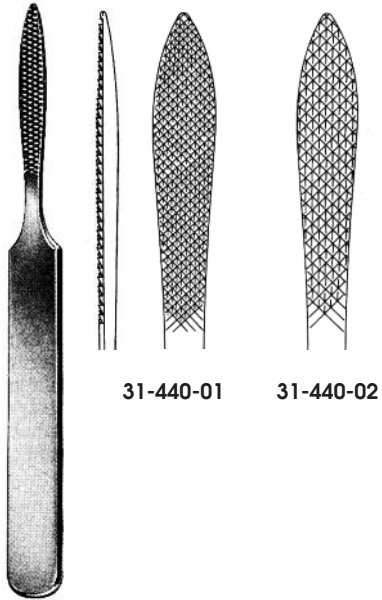

Josef, 16,5 cm

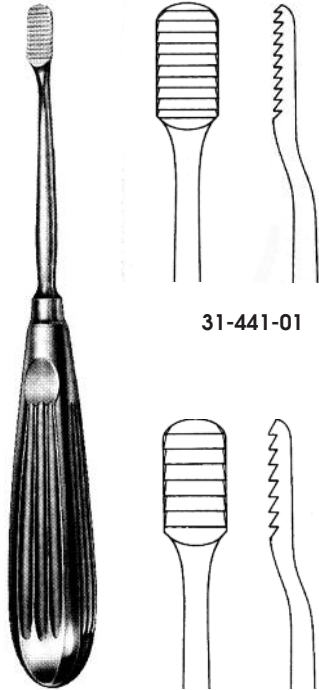

Lewis, 17,5 cm

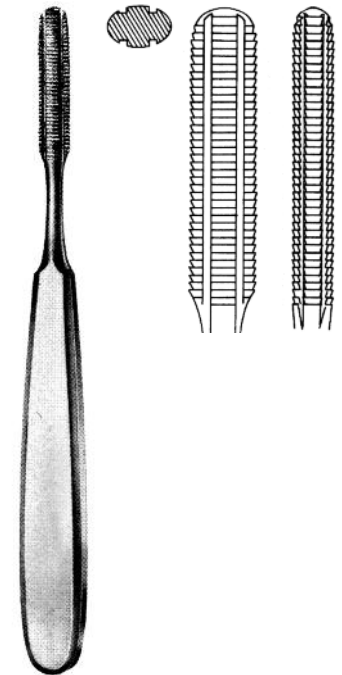

Maltz, 9,0 mm  
17,5 cm 31-442-18

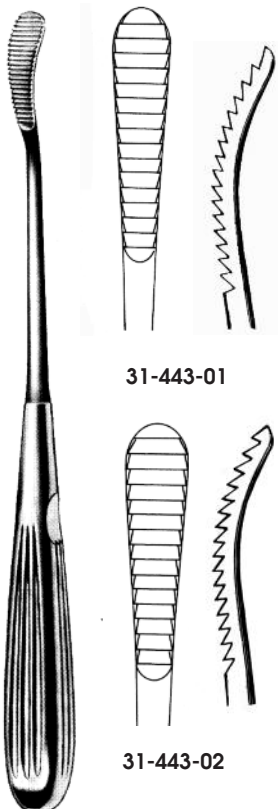

Aufricht, 22,0 cm



Gallaher, 19,0 cm



Fig. 1  
31-444-01

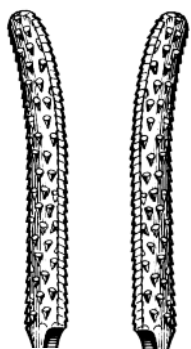
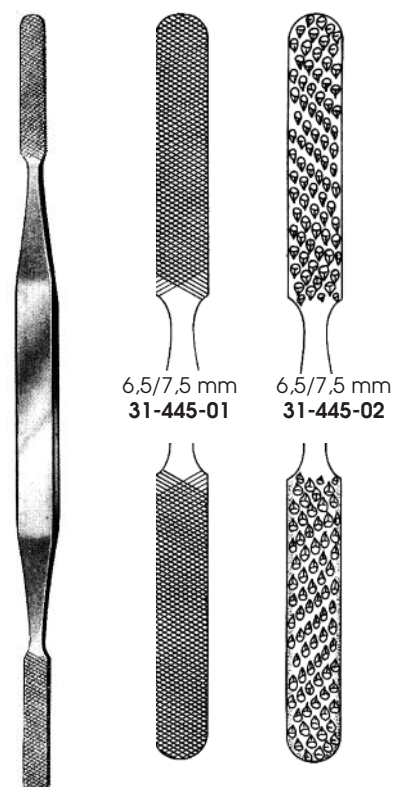

Fig. 2 31-444-02  
Fig. 3 31-444-03



Fomon, 21,5 cm



Raspel, 21,0 cm

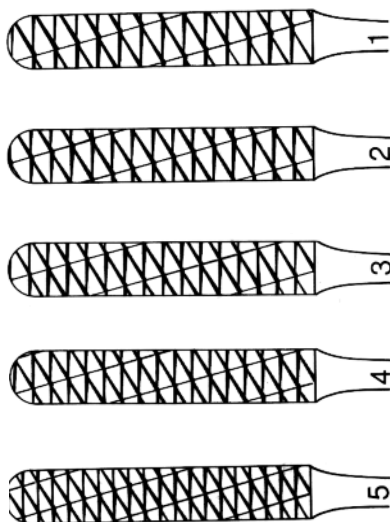
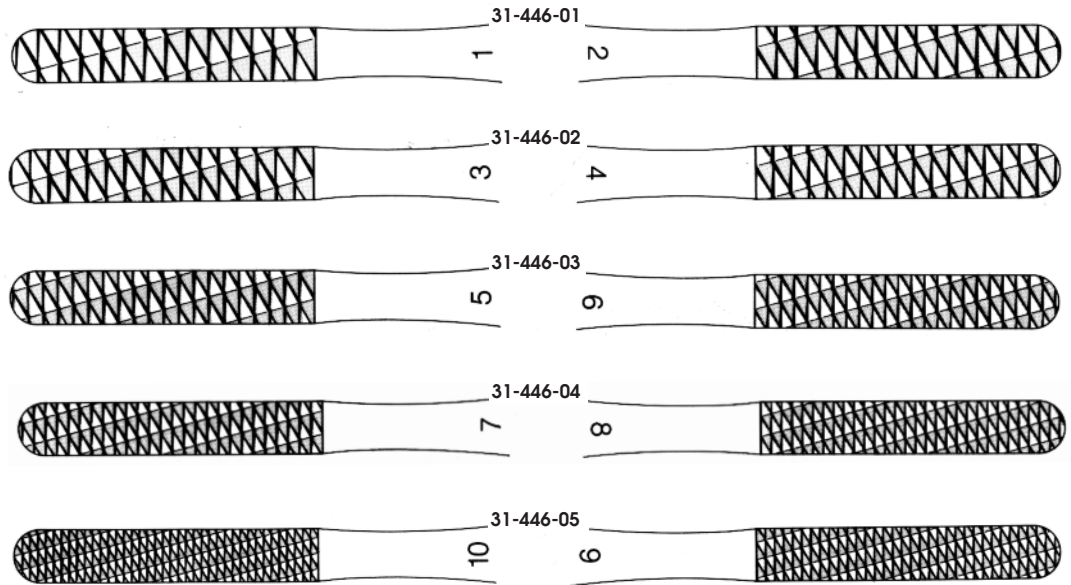

31-447-01  
 31-447-02  
 31-447-03  
 31-447-04  
 31-447-05

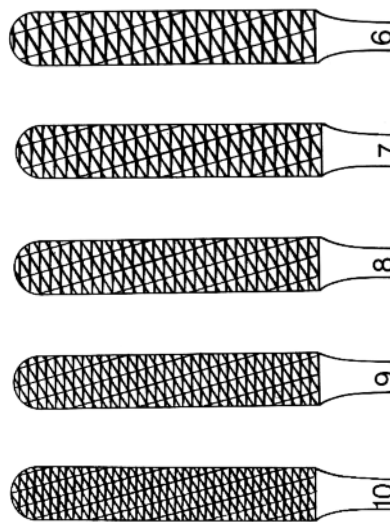

31-447-06  
 31-447-07  
 31-447-08  
 31-447-09  
 31-447-10

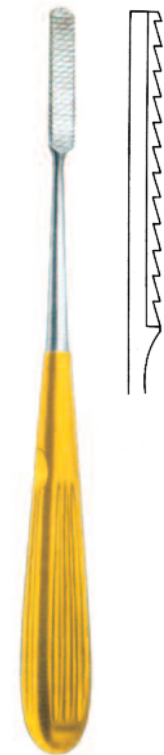

Maltz, 21,0 cm

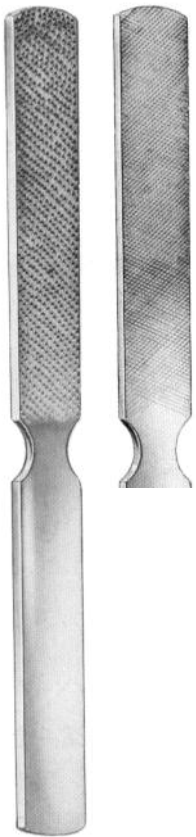

22,0 cm, 20 mm  
**31-448-22**

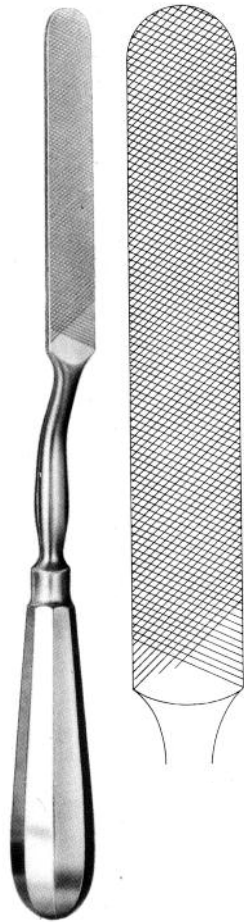

22,0 cm, 13 mm  
**31-449-24**

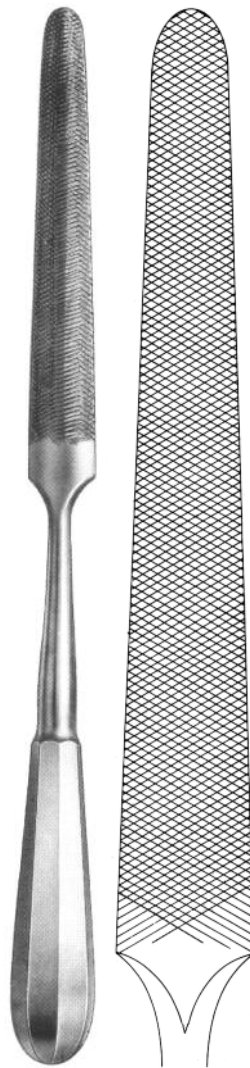

28,0 cm, 20 mm  
**31-449-28**



**Putti**  
27,0 cm, 18/20 mm  
**31-451-27**



**Putti**  
30,0 cm **31-452-30**





Wiener, 18,0 cm



31-453-01



31-453-02



Cottle

21,0 cm 31-454-21



Fig. 1  
31-455-01

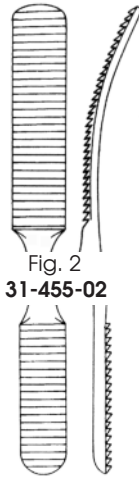

Fig. 2  
31-455-02

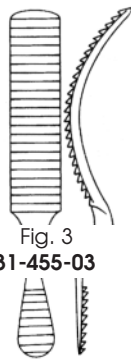

Fig. 3  
31-455-03

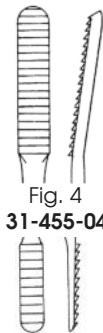

Fig. 4  
31-455-04

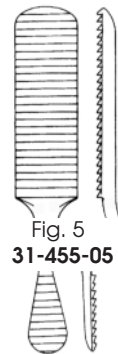

Fig. 5  
31-455-05



Miller, 19,0 cm



Fig. 1  
31-455-11



Fig. 2  
31-455-12

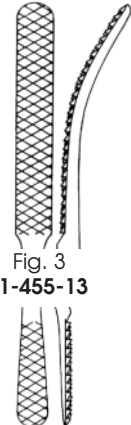

Fig. 3  
31-455-13



Fig. 4  
31-455-14



Miller, 19,0 cm

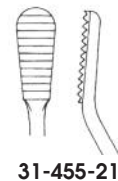

31-455-21

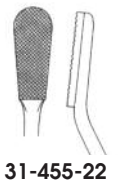

31-455-22



**Jacobson**  
14,0 cm  
31-460-01

**Martini**  
14,0 cm  
31-460-02

**Martini**  
14,0 cm  
31-460-03

**Williger**  
14,5 cm  
31-460-04

**Jansen**  
16,5 cm  
31-460-05

**Barth**  
18,0 cm  
31-460-06

**Volkmann**  
13,0 cm  
31-461-01

**Volkmann**  
16,0 cm  
31-461-02

**Volkmann**  
20,0 cm  
31-461-03

13,0 cm  
31-462-01

14,5 cm  
31-462-02

17,0 cm  
20,0 cm  
31-462-03  
31-462-04



16,0 cm  
31-463-01

**Jansen**  
16,0 cm  
31-463-02

**Hemmingway**  
17,0 cm  
31-463-03

17,0 cm  
31-463-04



Fig. 00/0  
31-464-01

Fig. 0/1  
31-464-02

Fig. 1/2  
31-464-03



Fig. 0000  
31-465-01

Fig. 000  
31-465-02

Fig. 00  
31-465-03

Fig. 0  
31-465-04

Fig. 1  
31-465-05

Fig. 2  
31-465-06

Fig. 3  
31-465-07

Fig. 4  
31-465-08

Fig. 5  
31-465-09

Fig. 6  
31-465-10

**Williger**, 13,5 cm

**Bruns**, 17,0 cm

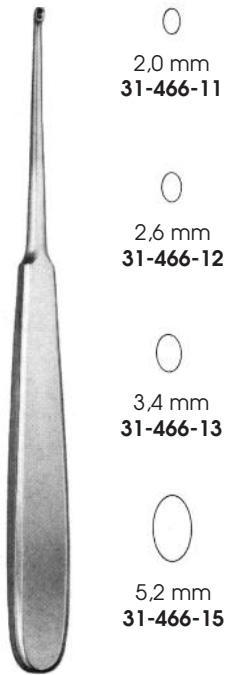

- 2,0 mm  
**31-466-11**
- 2,6 mm  
**31-466-12**
- 3,4 mm  
**31-466-13**
- 5,2 mm  
**31-466-15**

**Williger**, 17,0 cm



- Fig. 0000  
**31-467-01**
- Fig. 000  
**31-467-02**
- Fig. 00  
**31-467-03**
- Fig. 0  
**31-467-04**
- Fig. 1  
**31-467-05**
- Fig. 2  
**31-467-06**
- Fig. 3  
**31-467-07**
- Fig. 4  
**31-467-08**
- Fig. 5  
**31-467-09**
- Fig. 6  
**31-467-10**

**Volkmann**, 17,0 cm



- Fig. 0000  
**31-468-01**
- Fig. 000  
**31-468-02**
- Fig. 00  
**31-468-03**
- Fig. 0  
**31-468-04**
- Fig. 1  
**31-468-05**
- Fig. 2  
**31-468-06**
- Fig. 3  
**31-468-07**
- Fig. 4  
**31-468-08**
- Fig. 5  
**31-468-09**
- Fig. 6  
**31-468-10**

**Spratt**, 17,0 cm



- 1,0 mm  
21,0 cm **31-469-00**
- 1,7 mm  
21,0 cm **31-469-01**
- 2,0 mm  
21,0 cm **31-469-02**  
17,0 cm **31-469-20**
- 2,4 mm  
21,0 cm **31-469-03**  
17,0 cm **31-469-24**
- 2,7 mm  
21,0 cm **31-469-04**  
17,0 cm **31-469-27**
- 3,0 mm  
21,0 cm **31-469-05**  
17,0 cm **31-469-30**
- 3,3 mm  
17,0 cm **31-469-33**

**Lempert**



biegsam  
malleable

Halle, 21 cm

Fig. 1  
31-470-03

Fig. 2  
31-470-04

Fig. 3  
31-470-05

Daubenspeck  
20,0 cm

Fig. 0000  
31-471-03

Fig. 000  
31-471-04

Fig. 00  
31-471-05

Fig. 0  
31-471-06

25,0 cm

31-472-02 Fig. 000 31-473-02

31-472-03 Fig. 00 31-473-03

31-472-04 Fig. 0 31-473-04

31-472-05 Fig. 1 31-473-05

3,0 mm 31-473-13

4,0 mm 31-473-14

5,0 mm 31-473-15

Bushe, 25,0

Fig. 00000  
31-474-00

Fig. 0000  
31-474-01

Fig. 000  
31-474-02

Fig. 00  
31-474-03

Fig. 0  
31-474-04

Fig. 1  
31-474-05

Fig. 2  
31-474-06

Fig. 3  
31-474-07

Fig. 4  
31-474-08

Fig. 5  
31-474-09

Fig. 6  
31-474-10



Simon, 24,0 cm

17,0 cm      27,0 cm

**31-479-01** Fig. 0000

**31-479-02** Fig. 000

**31-479-03** Fig. 00

**31-479-04** Fig. 0      **31-480-04**

**31-479-05** Fig. 1      **31-480-05**

**31-479-06** Fig. 2      **31-480-06**

**31-479-07** Fig. 3      **31-480-07**

**Volkman**

17,0 cm      27,0 cm

**31-479-08** Fig. 4      **31-480-08**

**31-479-09** Fig. 5

**31-479-09** Fig. 6



**31-481-01**

**31-481-02**

**31-481-03**

**Scoville, 25,0 cm**



**31-483-01** Fig. 0000      **31-483-06** Fig. 2

**31-483-02** Fig. 000      **31-483-07** Fig. 3

**31-483-03** Fig. 00      **31-483-08** Fig. 4

**31-483-04** Fig. 0      **31-483-09** Fig. 5

**31-483-05** Fig. 1      **31-483-10** Fig. 6

**Bruns, 23,0 cm**













	Fig. 1	Fig. 2	Fig. 3	Fig. 4	Fig. 5	Fig. 6
						
<b>31-484-01</b>	<b>31-484-02</b>	<b>31-484-03</b>	<b>31-484-04</b>	<b>31-484-05</b>	<b>31-484-06</b>	
						
<b>31-485-01</b>	<b>31-485-02</b>	<b>31-485-03</b>	<b>31-485-04</b>	<b>31-485-05</b>	<b>31-485-06</b>	
						
<b>31-486-01</b>	<b>31-486-02</b>	<b>31-486-03</b>	<b>31-486-04</b>	<b>31-486-05</b>	<b>31-486-06</b>	



14,0 cm **31-502-14**



9,0 cm **31-503-09**  
13,0 cm **31-503-13**  
18,0 cm **31-503-18**



12,0 cm **31-506-12**



**Lewin**  
17,5 cm **31-508-17**



**Reill**  
17,0 cm **31-511-17**



20,5 cm **31-513-20**

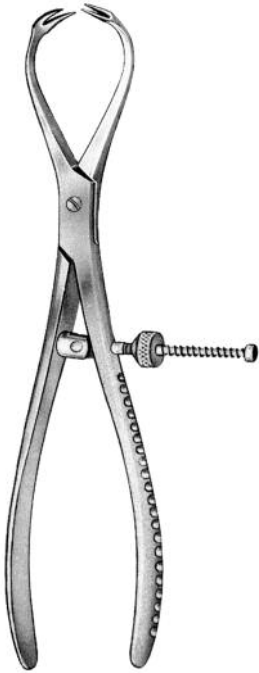

**Patellazange**  
 Patella Forceps  
 17,5 cm **31-516-18**



14,0 cm **31-519-14**

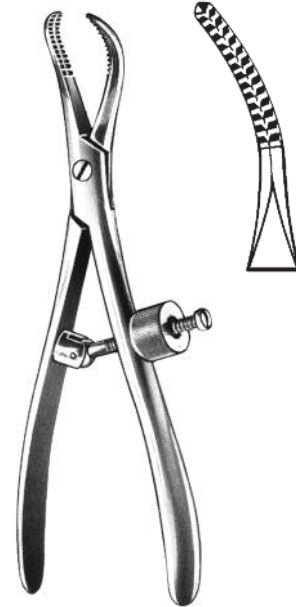

17,0 cm **31-521-17**  
 23,0 cm **31-521-23**

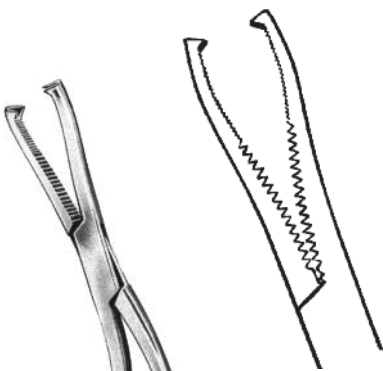

**31-523-18**

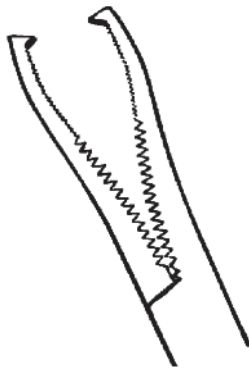

**31-523-19**

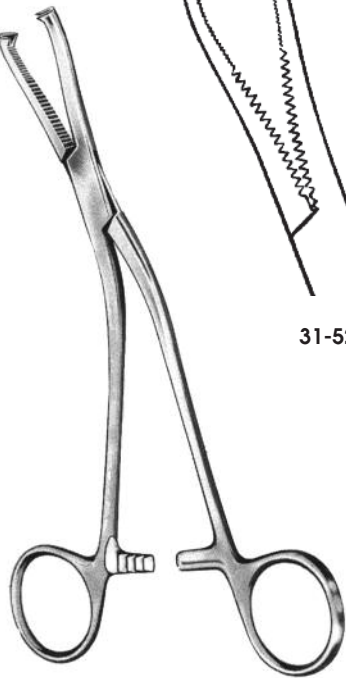

**Dingmann, 18,0cm**



**Sequesterzange**  
 Sequestrum Forceps  
 20,0 cm



**31-524-20**

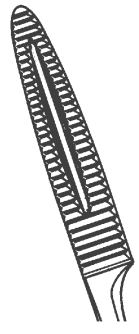

**31-525-20**

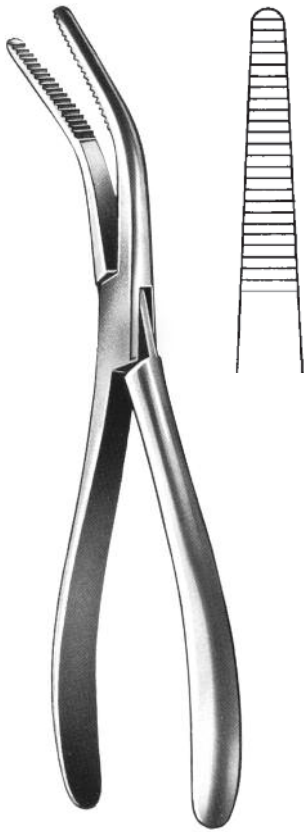

**Van Buren**  
22,5 cm 31-527-23



22,5 cm  
31-528-20



**Frosch**  
18,0 cm 31-529-18



**Langenbeck**  
20,0 cm 31-530-20



**Fergusson**  
20,0 cm 31-532-20



**Semb**  
19,0 cm 31-533-19

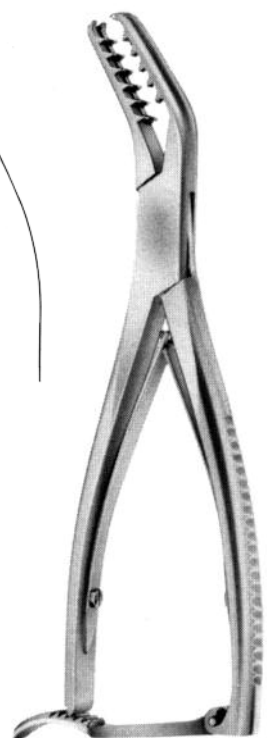

**Semb**  
19,0 cm 31-535-19





**Farabeuf**

23,0 cm **31-536-23** 9,0 mm  
 25,0 cm **31-536-25** 11,0 mm

**Farabeuf**

25,0 cm **31-538-25** 11,0 mm



**Kern-Lane**

15,0 cm **31-540-15**, 7,0 mm  
 17,0 cm **31-540-17**, 7,0 mm  
 21,0 cm **31-540-21**, 8,0 mm  
 24,0 cm **31-540-24**, 9,0 mm  
 33,0 cm **31-540-33**, 10,0 mm  
 45,0 cm **31-540-45**, 12,0 mm

**Kern-Lane**

15,0 cm **31-542-15**, 7,0 mm  
 17,0 cm **31-542-17**, 7,0 mm  
 21,0 cm **31-542-21**, 8,0 mm  
 24,0 cm **31-542-24**, 9,0 mm  
 33,0 cm **31-542-33**, 10,0 mm  
 45,0 cm **31-542-45**, 12,0 mm

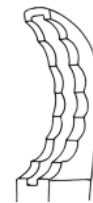

23,0 cm  
**31-546-23**  
**31-547-23**



25,0 cm  
**31-546-25**  
**31-547-25**



**Ulrich**

**31-546-23 - 31-546-28**

28,0 cm  
**31-546-28**  
**31-547-28**

**Ulrich**

**31-547-23 - 31-547-28**

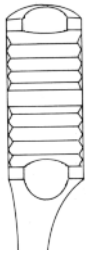

15,0 cm  
31-549-15



19,0 cm  
31-549-19

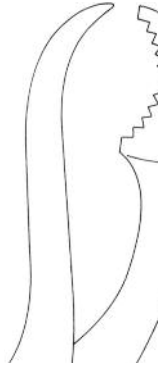

24,0 cm  
31-549-24

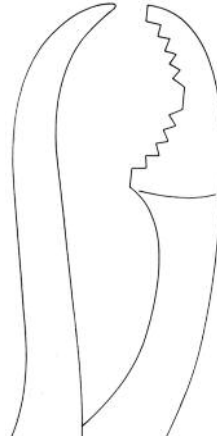

26,0 cm  
31-549-26

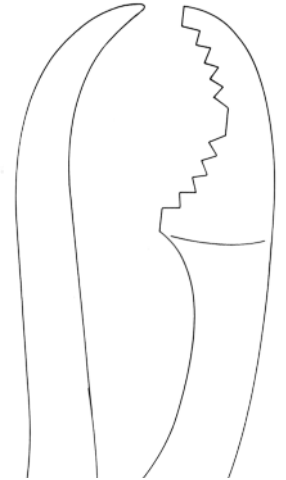

28,0 cm  
31-549-28

Selbstzentrierend mit Gewindesperre  
self-centering with thread fixation

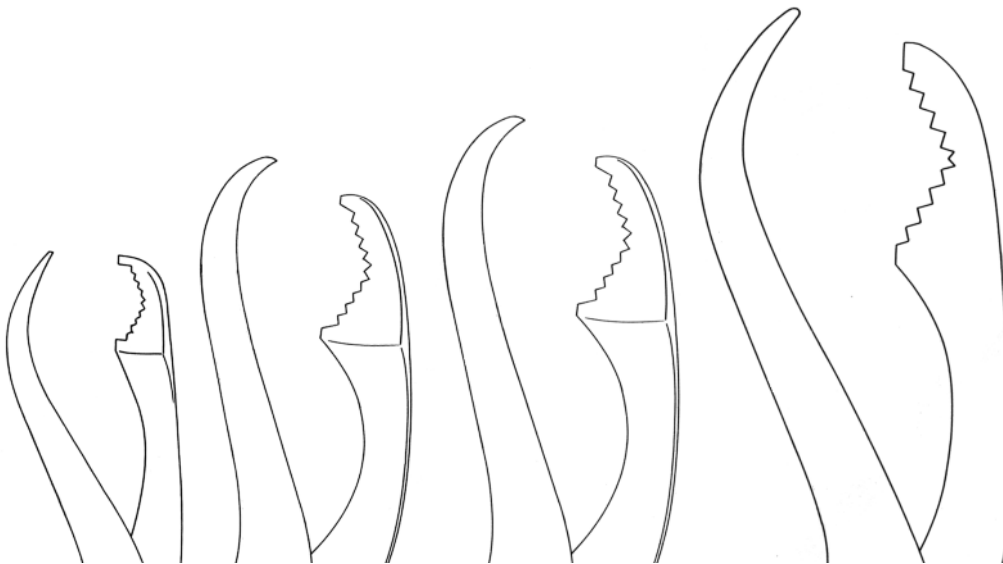

17,0 cm  
31-551-17

25,0 cm  
31-551-25

26,0 cm  
31-551-26

27,0 cm  
31-551-27

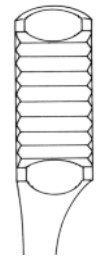

Verbrugge



verstellbar  
adjustable

**Lambothe**  
 22,0 cm **31-552-22**  
 27,0 cm **31-552-27**

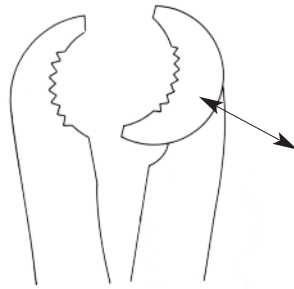

beweglich  
movable



**Lambothe**  
 22,0 cm **31-554-22**  
 26,0 cm **31-554-26**  
 33,0 cm **31-554-33**

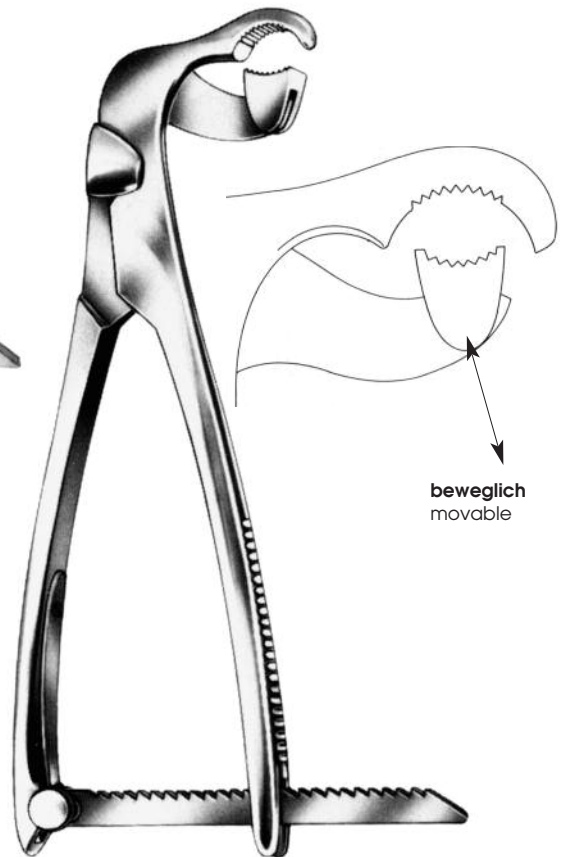
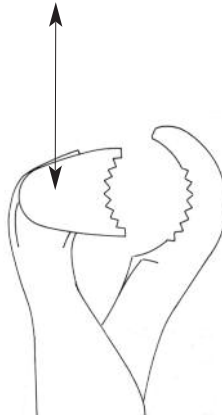

beweglich  
movable

**Lambothe**  
 19,0 cm **31-555-19**  
 23,0 cm **31-555-23**  
 26,0 cm **31-556-26**

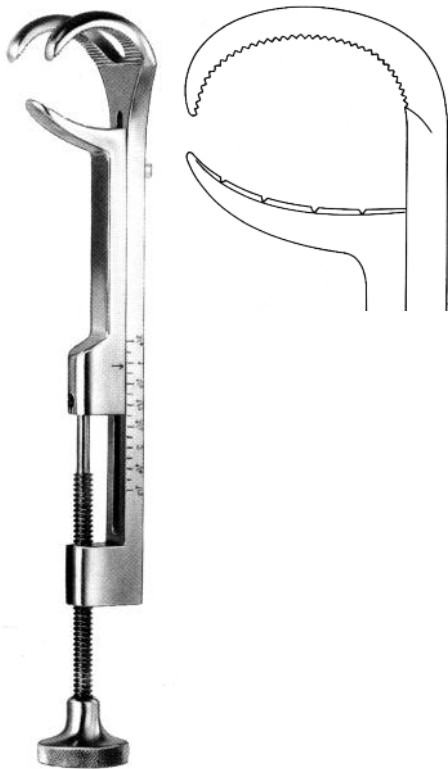

Lowmann  
31-561-13 - 31-561-22

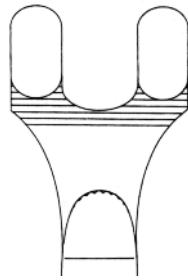

13,0 cm  
31-561-13

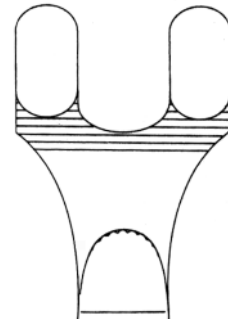

18,0 cm  
31-561-18

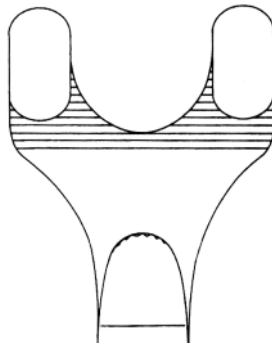

20,0 cm  
31-561-20

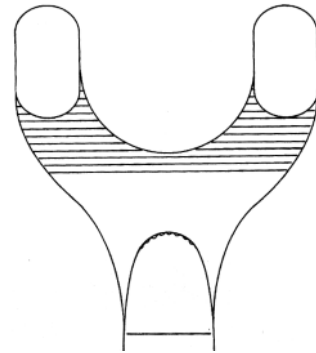

22,0 cm  
31-561-22



Gerster  
15,0 cm 31-564-00



31-601-01

**Synovektomie-Zange**  
 Synovectomy Rongeur  
 13 cm, 1,2 mm



31-601-02

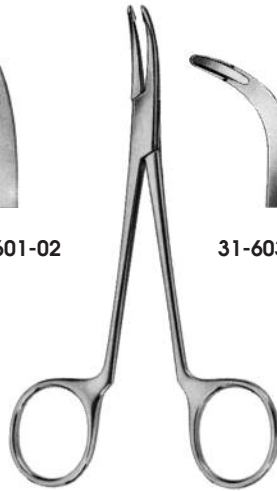

31-603-01

**Synovektomie-Zange**  
 Synovectomy Rongeur  
 13 cm, 2,0 mm



31-603-02



31-605-01

**Stellbrink, 17 cm**



31-605-02



**Friedmann**  
 12 cm 31-607-12



**Luer-Friedmann**  
 14,5 cm 31-607-14



**Friedmann-Vickers**  
 14,0 cm 31-608-14



31-611-01

**Luer, 15,0 cm**



31-611-02



31-611-03

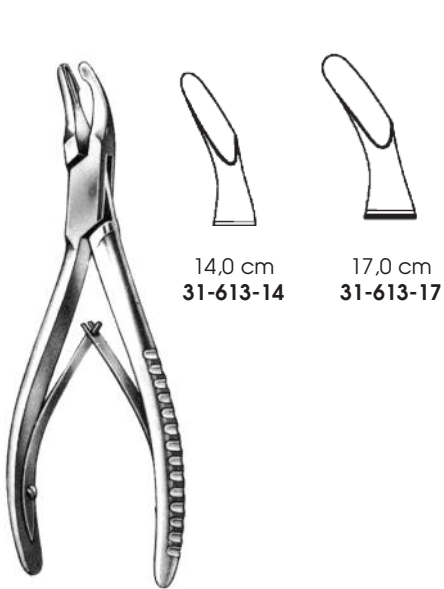

Cleveland

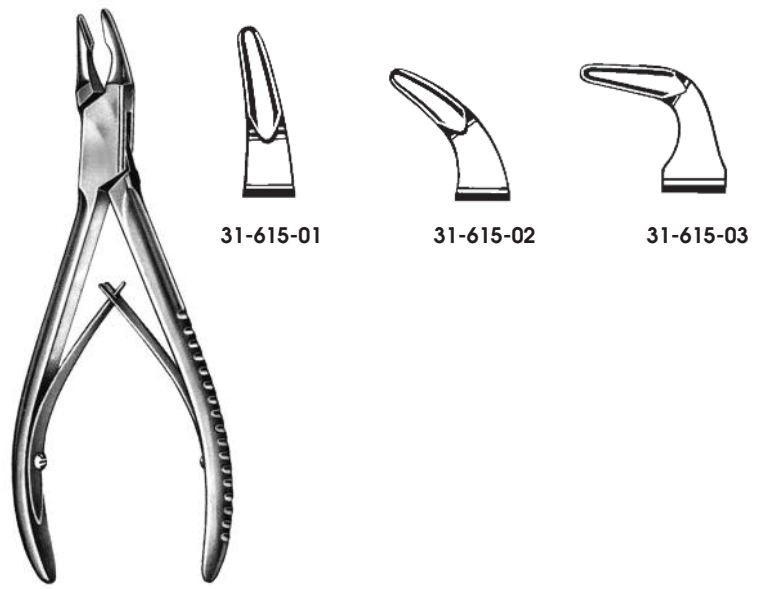

Blumenthal, 15,0 cm



Jansen, 17,0 cm



Hartmann  
17,0 cm 31-619-17

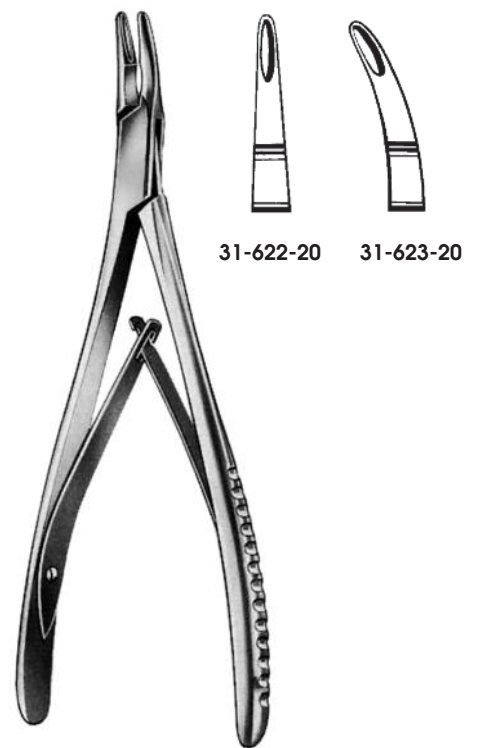

Lempert, 20,0 cm



**Mead, 16,5 cm**



**31-627-01**



**31-627-02**



**Luer**



17,0 cm  
**31-628-17**



17,0 cm  
**31-629-17**



18,0 cm  
**31-630-18**



18,0 cm  
**31-631-18**



**Böhler**



3,0 mm  
 15,0 cm  
**31-640-03**

4,0 mm  
 15,0 cm  
**31-640-04**

5,0 mm  
 5,0 cm  
**31-640-05**



3,0 mm  
 15,0 cm  
**31-641-03**

4,0 mm  
 15,0 cm  
**31-641-04**

5,0 mm  
 15,0 cm  
**31-641-05**



3,0 mm  
 15,5 cm  
**31-641-15**



**Mayfield**  
17,0 cm 31-645-17



**Marquardt**  
20,0 cm 31-647-20



**Beyer**  
18,0 cm 31-649-18



**Zaufal-Janson**  
18,0 cm 31-651-18



**Ruskin**



18,0 cm 31-653-05  
24,0 cm 31-655-05

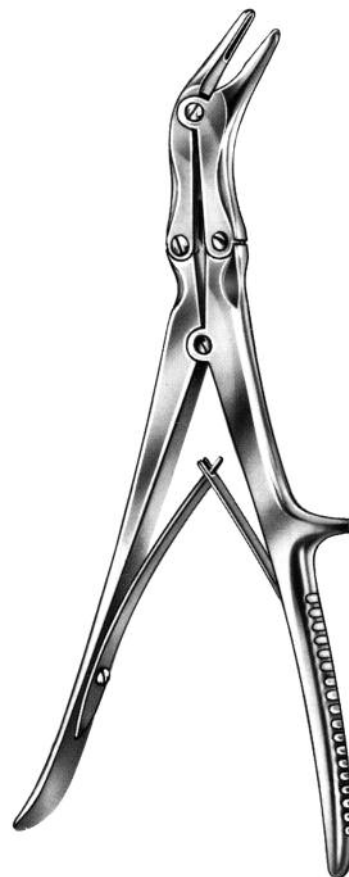

**Echlin, 23,0 cm**



31-658-02



31-658-03



31-658-04





**Frykholm**  
 24,0 cm 31-659-24



**Stille**  
 23,5 cm 31-660-06



**Leksell-Stille, 24,0 cm**



31-662-03



31-662-07



**Stille-Ruskin**  
 24,0 cm  
 31-663-24



**Luer-Stille, 22,0 cm**



31-664-22



31-665-22



Luer-Stille



23,0 cm  
31-666-23

27,0 cm  
31-666-27



23,0 cm  
31-667-23

27,0 cm  
31-667-27



Markwalder  
19,0 cm 31-669-19

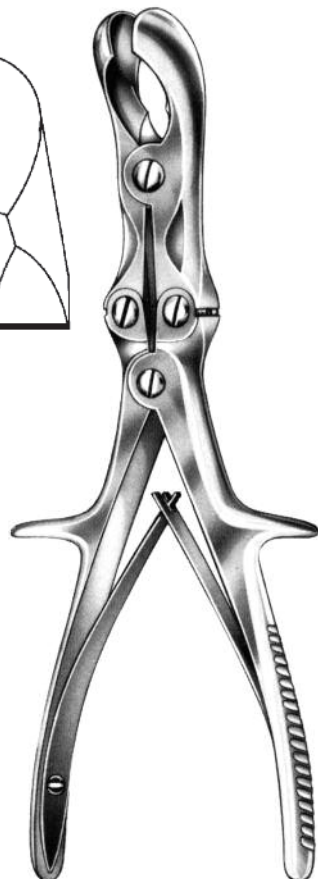

Semb  
24,0 cm 31-669-24



31-670-01

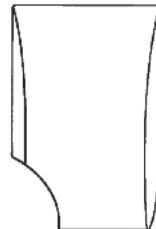

31-670-02

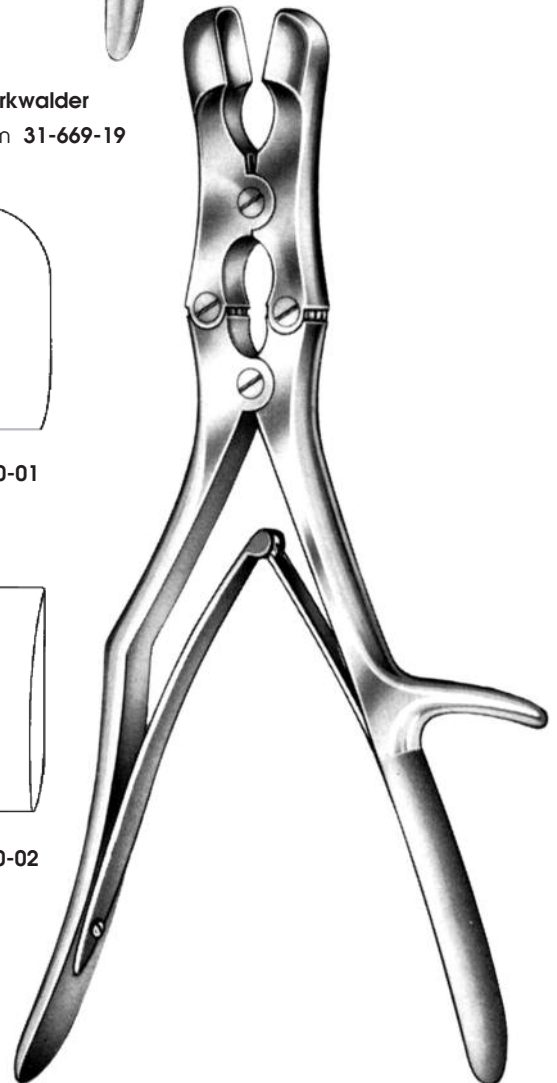

Sauerbruch-Coryllos, 31,0 cm

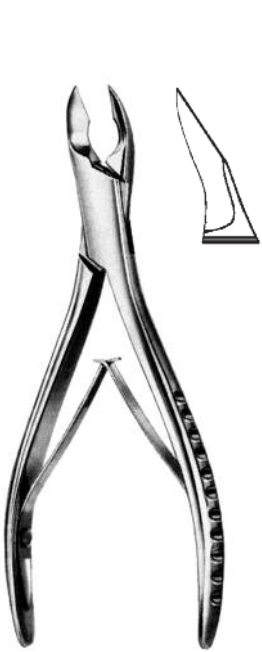

**Cleveland**  
 15,0 cm 31-701-15



**Cleveland**  
 17,0 cm 31-701-17



**Gardner, 16,0 cm**



4,0 mm  
 31-703-04



6,0 mm  
 31-703-06



**Cottle**  
 19,0 cm 31-704-19



**Liston**



14,0 cm  
 31-706-14



17,0 cm  
 31-706-17



20,0 cm  
 31-706-20



22,0 cm  
 31-706-22



14,0 cm  
 31-707-14



17,0 cm  
 31-707-17

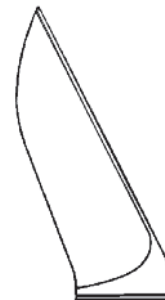

20,0 cm  
 31-707-20

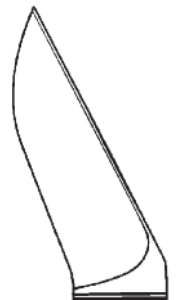

22,0 cm  
 31-707-22



**Böhler**  
15,0 cm  
31-708-15



**Mc Indoe**  
17,5 cm  
31-711-18



**Böhler**  
15,0 cm  
31-709-15



19,0 cm  
31-712-19



19,0 cm  
31-713-19

Ruskin- Liston



Liston



**Liston**  
28,0 cm  
31-714-28



**Liston**  
24,0 cm  
31-715-24



**Liston**  
28,0 cm  
31-715-28

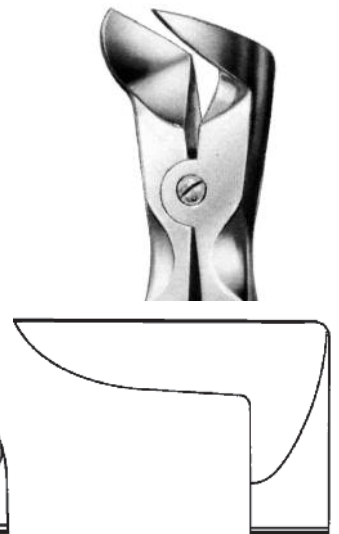

**Liston-Stillé**  
27,0 cm  
31-717-27



**Liston-Key**  
27,0 cm 31-719-27



**Semb**  
24,0 cm 31-721-24

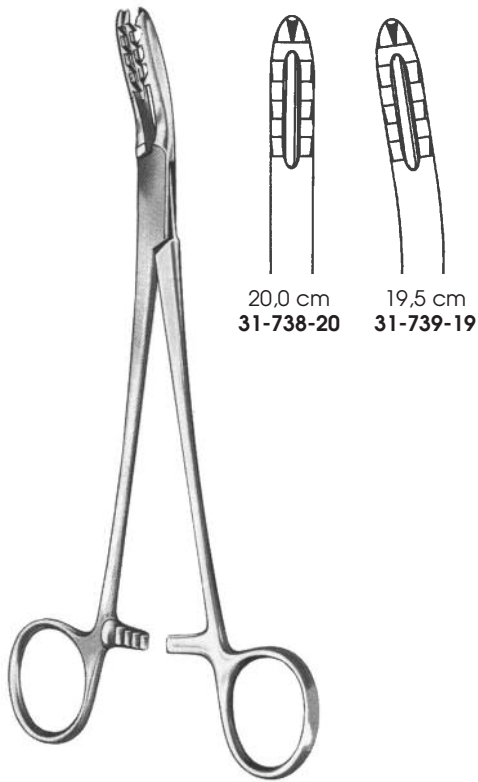

20,0 cm 31-738-20  
19,5 cm 31-739-19

**Bircher-Ganske**

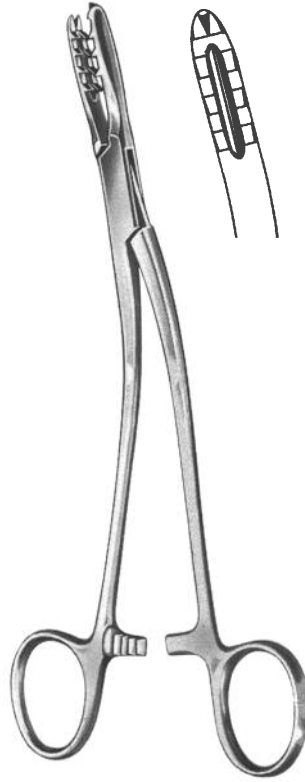

**Bircher-Ganske**  
20,0 cm 31-739-20



**Martin**  
20,5 cm 31-740-20

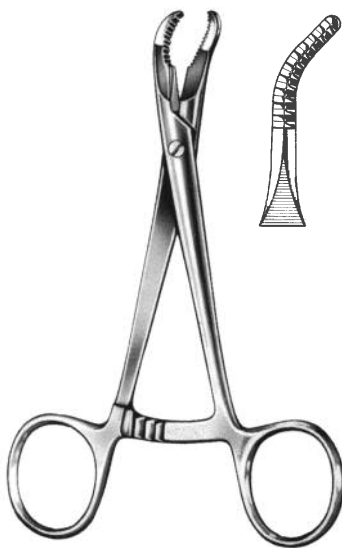

**Knorpelzange**  
Cartilage Seizing Forceps  
13,5 cm 31-741-14



**Neff**, 13,5 cm

31-742-01 31-747-02

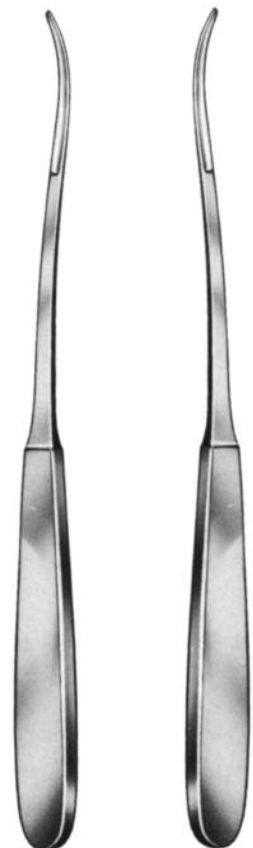

**Salenius**, 22,0 cm  
31-745-01 31-745-02



**Bircher, 19,5 cm**



**31-754-01**

**31-754-02**



**Smillie**  
 17,0 cm **31-755-01**



**Smillie**  
 17,0 cm **31-755-02**



**Smillie**  
 17,0 cm **31-755-03**



**Smillie, 14,0 cm**



**31-760-01** 32x19 mm  
**31-760-02** 48x19 mm  
**31-760-03** 57x19 mm



**31-760-04** 52x13 mm



**31-760-05** 12 x 13 mm



**Blount**, 40 x 4 mm  
17,5 cm **31-762-17**



75 x 30 mm  
17,0 cm **31-763-17**



**Taylor**  
16,5 cm, 75 x 30 mm **31-764-01**  
16,5 cm, 100 x 30 mm **31-764-02**

**Sehnenflechtklemme**  
Tendon Interlacing Forceps

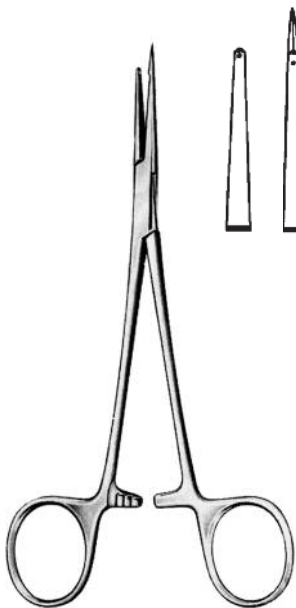

15,0 cm **31-770-15**

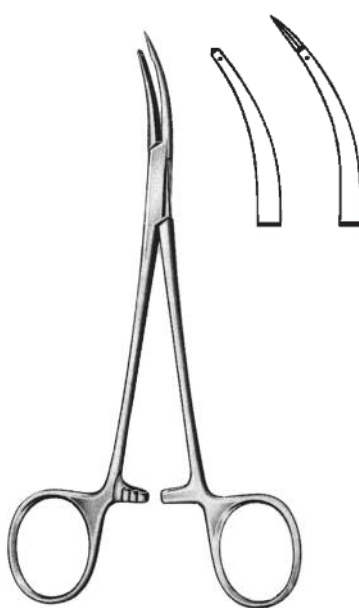

15,0 cm **31-771-15**

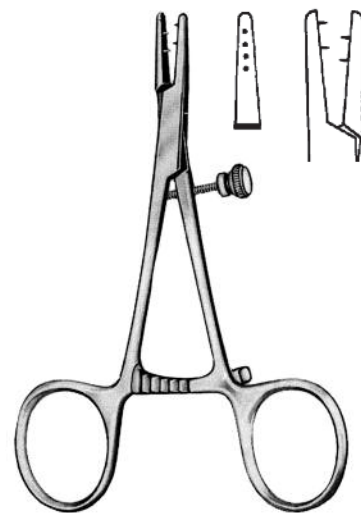

**Sehnenfaßzange**  
Tendon Seizing Forceps  
12,0 cm **31-772-12**



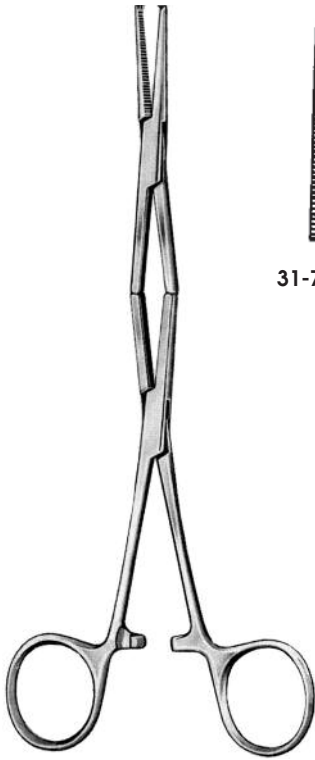

**Sehnenfaßzange**  
 Tendon Seizing Forceps  
 20,5 cm

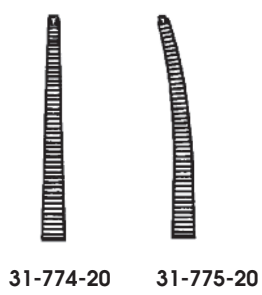

31-774-20 31-775-20



**Sehnenfaßzange**  
 Tendon Seizing Forceps  
 11,0 cm 31-777-11



15,0 cm

31-778-15 **gerade/straight**  
 31-779-18 **gebogen/curved**



18,0 cm

31-778-18 **gerade/straight**  
 31-779-18 **gebogen/curved**



24,0 cm

31-778-24 **gerade/straight**  
 31-779-24 **gebogen/curved**



**Brand**  
**Sehnenfaßzange**  
 Tendon Seizing Forceps

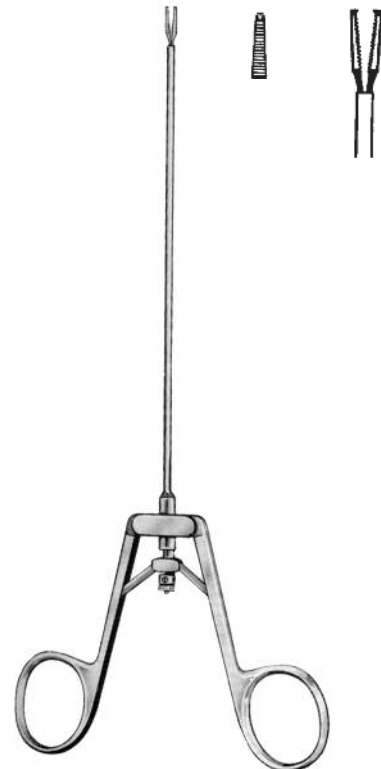

**Kleinert-Kutz**  
**Sehnedurchziehzange**  
 Tendon Passing Forceps  
 20,5 cm 31-781-20



**Kirschner**

- 95 x 70 mm **31-801-01**
- 95 x 110 mm **31-801-02**
- 105 x 110 mm **31-801-03**
- 120 x 120 mm **31-801-04**
- 135 x 130 mm **31-801-05**
- 155 x 155 mm **31-801-06**
- 200 x 155 mm **31-801-07**



verstellbar  
adjustable

- 40 - 140 **31-802-01**
- 65 - 140 **31-802-02**
- 60 - 220 **31-802-03**



**Kirschner, amerik. Modell**  
American type

- max. 105 mm **31-803-01**
- max. 160 mm **31-803-02**
- max. 200 mm **31-803-03**



**Böhler**

- 16 x 9 mm **31-804-01**
- 21 x 11 mm **31-804-02**
- 21 x 15 mm **31-804-03**



**Spannschlüssel  
mit Klemmbacke**  
wire tightener  
with clamping jaws  
**31-804-01**



**Gabelschlüssel**  
Wrench  
**31-806-01**



**Zughaken**  
Traction hook  
**31-807-00**



**Zughaken, allein**  
Traction hook  
**31-808-00**

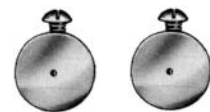

**Fixierscheiben, Paar**  
Fication Disc, pair  
**31-809-00**



**Handbohrfutter**  
 Spannweite bis Ø 4,5 mm  
 Drilling chuck  
 for shanks up to Ø 4,5 mm  
 6,35 mm **31-813-00**



**Handbohrfutter**  
 Spannweite bis 6,35 mm  
 Drilling chuck  
 for shanks up to 6,35 mm  
**31-816-00**



**Spannschlüssel zu**  
**Bohrfutter 31-816-00**  
 Key for drilling chuck 31-816-00  
**31-816-01**



**Cerclage-Draht, weich**  
 Wire, soft

10 m x 0,2 mm	<b>31-821-02</b>
10 m x 0,3 mm	<b>31-821-03</b>
10 m x 0,4 mm	<b>31-821-04</b>
10 m x 0,5 mm	<b>31-821-05</b>
10 m x 0,6 mm	<b>31-821-06</b>
10 m x 0,7 mm	<b>31-821-07</b>
10 m x 0,8 mm	<b>31-821-08</b>
10 m x 0,9 mm	<b>31-821-09</b>
10 m x 1,0 mm	<b>31-821-10</b>
10 m x 1,2 mm	<b>31-821-12</b>
10 m x 1,5 mm	<b>31-821-15</b>
10 m x 2,0 mm	<b>31-821-20</b>

**Cerclage-Draht, TITAN**  
 Wire, TITAN

10 m x 0,8 mm	<b>31-821-38</b>
10 m x 1,0 mm	<b>31-821-40</b>

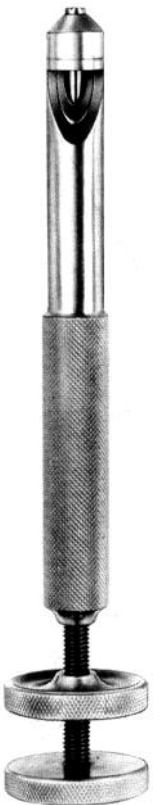

**Loute**  
**Drahtspanner**  
 Wire tightener  
 22,0 cm **31-822-22**



**Demel**  
**Drahtspannzange**  
 Wire tightening forceps  
 27,0 cm **31-824-27**



**Demel**

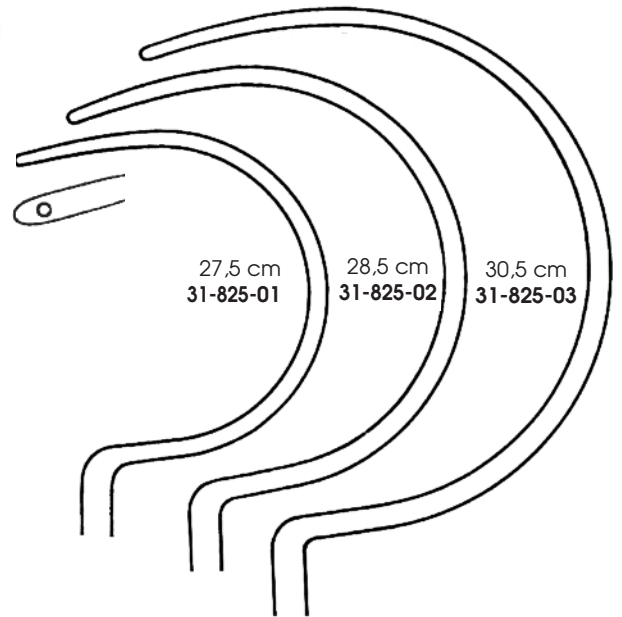

**Drahtumführungsinstrument/Wire Guide**

27,5 cm **31-825-01**    28,5 cm **31-825-02**    30,5 cm **31-825-03**

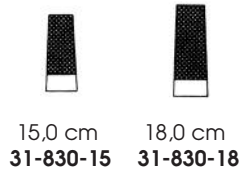

15,0 cm 31-830-15  
18,0 cm 31-830-18

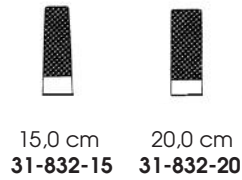

15,0 cm 31-832-15  
20,0 cm 31-832-20

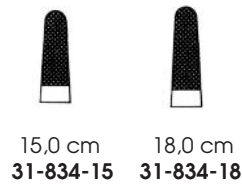

15,0 cm 31-834-15  
18,0 cm 31-834-18

31-830-15 - 83-834-18



15,0 cm 31-835-15



18,5 cm 31-836-18

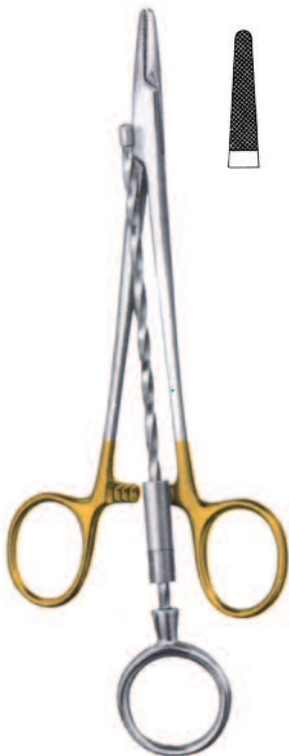

**Corwig-Hegar**  
16,0 cm 31-838-16



14,0 cm 31-850-14

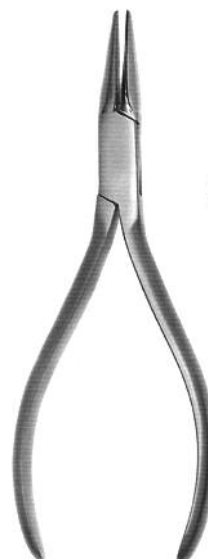

31-851-01 - 31-851-03

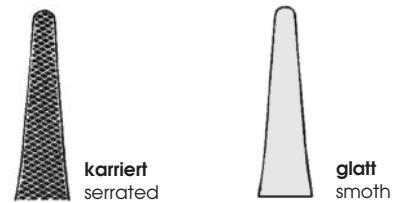

**31-851-01** 14,0 cm  
**beidseits karriert**  
jaws serrated

**31-851-02** 14,0 cm  
**eine Seite karriert, eine Seite glatt**  
one jaw serrated, one jaw smooth

**31-851-03** 14,0 cm  
**beidseits glatt**  
jaws smooth



15,0 cm **31-852-15**



16,0 cm **31-852-16**

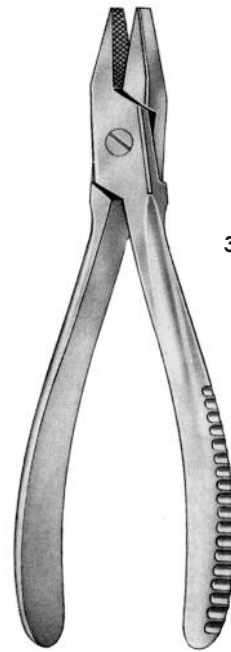

**31-854-01 - 31-854-03**



17,0 cm  
**31-854-01**



17,0 cm  
**31-854-02**



19,0 cm  
**31-854-03**



17,0 cm **31-856-17**

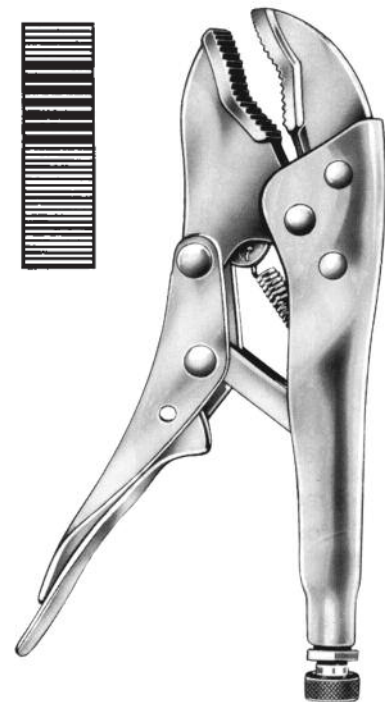

18,0 cm **31-858-18**

Standard

TC



31-862-01



31-863-01

31-862-02



31-863-02

31-862-03



31-863-03



18,0 cm 31-864-18



12,0 cm 31-865-12  
14,0 cm 31-868-14

18,0 cm  
31-862-01 - 31-863-03

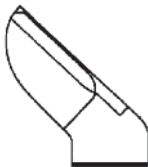

22,0 cm 31-873-22

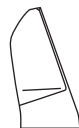

17,0 cm 31-874-17



14,5 cm 31-882-14



16,0 cm 31-884-16



18,0 cm 31-886-18

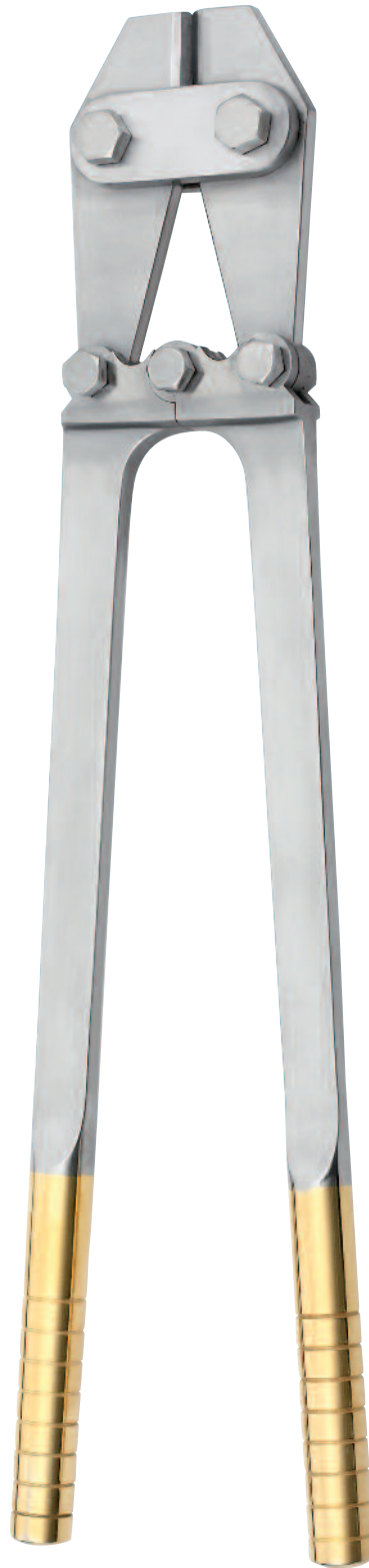

47,0 cm **31-890-47**  
57,0 cm **31-890-57**

**31-890-98 Ersatzschneide (Paar) für 31-890-47**  
**31-890-99 Ersatzschneide (Paar) für 31-890-45**

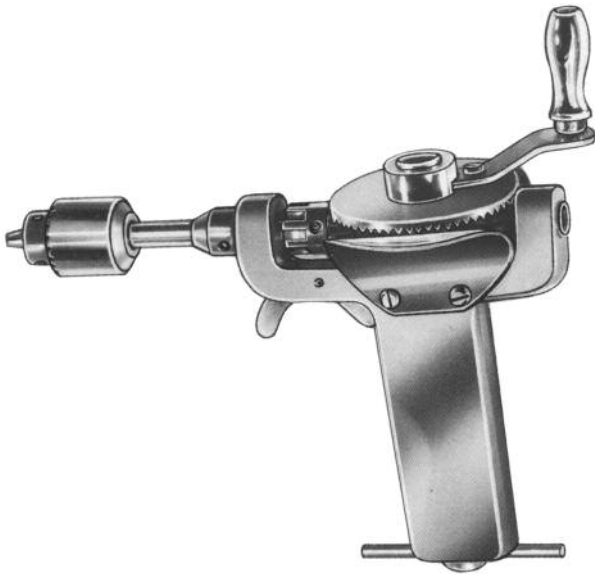

**Bunnell**  
31-909-00



31-914-00

**Hudson, komplett**  
Hudson, complete  
31-916-00



**Verlängerung**  
Extension piece  
31-916-09

**Hudson, allein**  
Hudson, alone  
31-916-10



**Hudson**  
Fig. 1 Ø 9 mm  
31-916-01



**Hudson**  
Fig. 2 Ø 14 mm  
31-916-02



**Hudson**  
Fig. 3 Ø 16 mm  
31-916-03



**Hudson**  
Fig. 3 Ø 22 mm  
31-916-04



**Cushing**  
Ø 14 mm  
31-916-05



**Hudson**  
Ø 2 mm  
31-916-06



**Mc Kenzie**  
Ø 13 mm  
31-916-07



**Adson**  
Ø 15 mm  
31-916-08



