

03

Pinzetten
Forceps



Standard

10,0 cm **03-000-10**
11,0 cm **03-000-11**
13,0 cm **03-000-13**
14,0 cm **03-000-14**
16,0 cm **03-000-16**
18,0 cm **03-000-18**
20,0 cm **03-000-20**
25,0 cm **03-000-25**
30,0 cm **03-000-30**



Standard

10,0 cm **03-001-10**
11,0 cm **03-001-11**
13,0 cm **03-001-13**
14,0 cm **03-001-14**
16,0 cm **03-001-16**
18,0 cm **03-001-18**
20,0 cm **03-001-20**
25,0 cm **03-001-25**
30,0 cm **03-001-30**



**waska
narrow**

Standard

11,0 cm **03-002-11**
13,0 cm **03-002-13**
14,0 cm **03-002-14**
16,0 cm **03-002-16**
18,0 cm **03-002-18**
20,0 cm **03-002-20**
25,0 cm **03-002-25**
30,0 cm **03-002-30**



**waska
narrow**

Standard

11,0 cm **03-003-11**
13,0 cm **03-003-13**
14,0 cm **03-003-14**
16,0 cm **03-003-16**
18,0 cm **03-003-18**
20,0 cm **03-003-20**
25,0 cm **03-003-25**
30,0 cm **03-003-30**



**delikatna
delicate**

Standard

10,0 cm **03-004-10**
11,5 cm **03-004-11**
13,0 cm **03-004-13**
14,0 cm **03-004-14**
16,0 cm **03-004-16**
18,0 cm **03-004-18**
20,0 cm **03-004-20**



**Model Szwedzki
Sweden pattern**

13,0 cm **03-006-13**
15,0 cm **03-006-15**
17,0 cm **03-006-17**
20,0 cm **03-006-20**



**Pinceta mikroskopowa
Microscopic forceps**

9,0 cm **03-008-09**
10,5 cm **03-008-10**
11,5 cm **03-008-11**
13,0 cm **03-008-13**
14,5 cm **03-008-14**



**Pinceta mikroskopowa
Microscopic forceps**

9,0 cm **03-009-09**
10,5 cm **03-009-10**
11,5 cm **03-009-11**
13,0 cm **03-009-13**
14,5 cm **03-009-14**



Mikroskopier Pinzette
 Microscopic Forceps

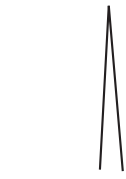

10,0 cm **03-010-10**



10,0 cm **03-011-10**



Modell USA

- 12,0 cm **03-020-12**
- 13,0 cm **03-020-13**
- 14,0 cm **03-020-14**
- 15,0 cm **03-020-15**
- 18,0 cm **03-020-18**
- 21,0 cm **03-020-21**
- 25,0 cm **03-020-25**
- 31,0 cm **03-020-31**



schmal
 narrow

Modell USA

- 12,0 cm **03-022-12**
- 13,0 cm **03-022-13**
- 14,0 cm **03-022-14**
- 15,0 cm **03-022-15**



Stille

- 11,0 cm **03-030-11**
- 13,0 cm **03-030-13**
- 15,0 cm **03-030-15**
- 17,0 cm **03-030-17**
- 20,0 cm **03-030-20**



Feine anat. Pinzette
 Delicate Dissecting Forceps



10,0 cm **03-034-10**



10,0 cm **03-035-10**



10,0 cm **03-035-11**



Adson

12,0 cm **03-040-12**



Adson

12,0 cm **03-042-12**
15,0 cm **03-042-15**



schmal
narrow



Adson

12,0 cm **03-044-12**



fein
delicate



Adson

12,0 cm **03-046-12**



mikro
micro



Adson

12,0 cm **03-047-12**



fein
delicate



Mc Indoe

15,0 cm **03-050-15**



Gillies

15,0 cm **03-052-15**



Semken
 12,0 cm **03-054-12**
 15,0 cm **03-054-15**



Semken
 12,0 cm **03-055-12**
 15,0 cm **03-055-15**



Taylor

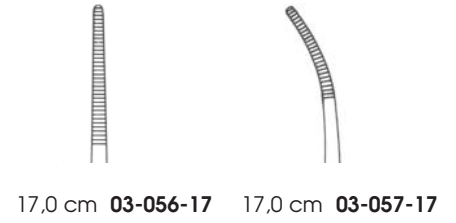

Taylor

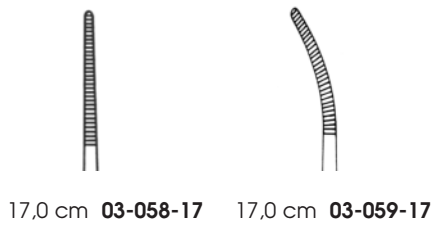

Taylor
 17,0 cm **03-061-17**



Mikro-Pinzette
 Micro Forceps

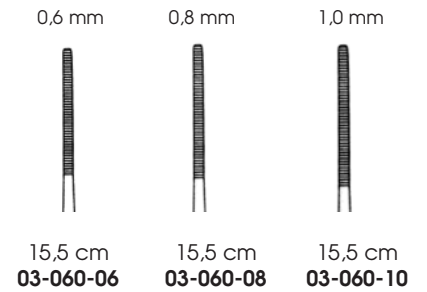



Potts-Smith
18,0 cm **03-064-18**
21,0 cm **03-064-21**
25,0 cm **03-064-25**
30,0 cm **03-064-30**



Potts-Smith
18,0 cm **03-065-18**
21,0 cm **03-065-21**
25,0 cm **03-065-25**
30,0 cm **03-065-30**



Cushing
17,0 cm **03-066-17**



Cushing
17,0 cm **03-067-17**



Brophy
20,0 cm **03-068-20**



Brophy
20,0 cm **03-069-20**



Gerald
18,0 cm **03-070-18**
23,0 cm **03-070-23**



Gerald
18,0 cm **03-071-18**



Duval

14,5 cm **03-082-14**



Russ. Modell

15,0 cm **03-084-15**
 20,0 cm **03-084-20**
 25,0 cm **03-084-25**
 30,0 cm **03-084-30**



Mayo Russ. Modell

23,0 cm **03-084-23**



Wangenstein

23,0 cm **03-086-23**



Tuttle

23,0 cm **03-088-23**

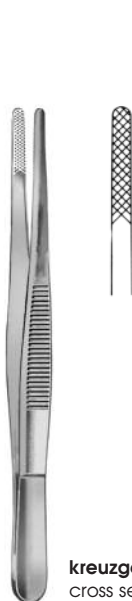

kreuzgerieft
 cross serrated

Standard
 13,0 cm **03-092-13**
 16,0 cm **03-092-16**

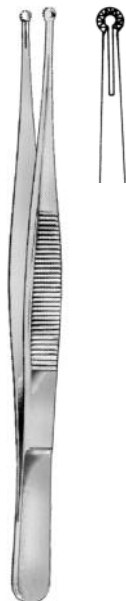

Selmann
 16,0 cm **03-094-15**
 20,0 cm **03-094-20**
 25,0 cm **03-094-25**



waska
narrow



waska, zakrzywiona
narrow, curved

Standard

- 11,0 cm **03-103-11**
- 13,0 cm **03-103-13**
- 14,0 cm **03-103-14**
- 16,0 cm **03-103-16**
- 18,0 cm **03-103-18**
- 20,0 cm **03-103-20**
- 25,0 cm **03-103-25**
- 30,0 cm **03-103-30**



delikatna
delicate



Standard

- 10,0 cm **03-100-10**
- 11,0 cm **03-100-11**
- 13,0 cm **03-100-13**
- 14,0 cm **03-100-14**
- 15,0 cm **03-100-15**
- 16,0 cm **03-100-16**
- 18,0 cm **03-100-18**
- 20,0 cm **03-100-20**
- 23,0 cm **03-100-23**
- 25,0 cm **03-100-25**
- 30,0 cm **03-100-30**

Standard

- 11,0 cm **03-102-11**
- 13,0 cm **03-102-13**
- 14,0 cm **03-102-14**
- 16,0 cm **03-102-16**
- 18,0 cm **03-102-18**
- 20,0 cm **03-102-20**
- 25,0 cm **03-102-25**
- 30,0 cm **03-102-30**

Standard

- 13,0 cm **03-104-13**
- 14,0 cm **03-104-14**
- 16,0 cm **03-104-16**
- 20,0 cm **03-104-20**

Waugh

- 18,0 cm **03-106-18**
- 20,0 cm **03-106-20**
- 25,0 cm **03-106-25**
- 30,0 cm **03-106-30**



2:3



3:4



4:5

Standard USA

- 11,0 cm **03-120-11**
- 13,0 cm **03-120-13**
- 14,0 cm **03-120-14**
- 15,0 cm **03-120-15**
- 18,0 cm **03-120-18**
- 20,0 cm **03-120-20**
- 25,0 cm **03-120-25**
- 30,0 cm **03-120-30**

Standard USA

- 13,0 cm **03-122-13**
- 14,0 cm **03-122-14**
- 15,0 cm **03-122-15**
- 18,0 cm **03-122-18**
- 21,0 cm **03-122-21**
- 25,0 cm **03-122-25**
- 31,0 cm **03-122-31**

Standard

- 11,0 cm **03-124-11**
- 13,0 cm **03-124-13**
- 14,0 cm **03-124-14**
- 15,0 cm **03-124-15**
- 16,0 cm **03-124-16**
- 18,0 cm **03-124-18**
- 20,0 cm **03-124-20**
- 25,0 cm **03-124-25**
- 30,0 cm **03-124-30**

Standard

- 13,0 cm **03-126-13**
- 14,0 cm **03-126-14**
- 15,0 cm **03-126-15**
- 16,0 cm **03-126-16**

Standard

- 13,0 cm **03-128-13**
- 14,0 cm **03-128-14**
- 16,0 cm **03-128-16**



1:2

Stille
 15,0 cm **03-129-15**



2:3

Stille
 15 cm **03-130-15**



fein 1,0 mm
 delicate, 1,0 mm



10,0 cm **03-134-10**



10,0 cm **03-135-10**



10,0 cm **03-135-11**



Adson



12,0 cm **03-140-12**
 15,0 cm **03-140-15**



12,0 cm **03-142-12**
 15,0 cm **03-142-15**

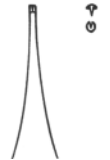

12,0 cm **03-144-12**
 15,0 cm **03-144-15**
 18,0 cm **03-144-18**



12,0 cm **03-146-12**



12,0 cm **03-147-12**

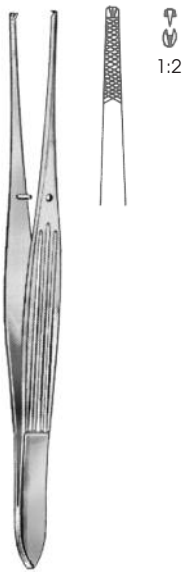

Mc Indoe
15,0 cm **03-150-15**

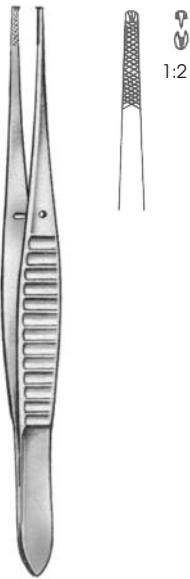

Gillies
15,0 cm **03-152-15**



Semken

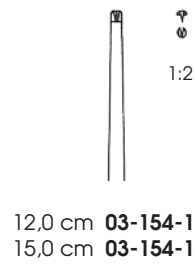

12,0 cm **03-154-12**
15,0 cm **03-154-15**

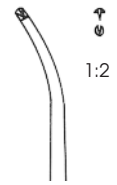

12,0 cm **03-155-12**
15,0 cm **03-155-15**

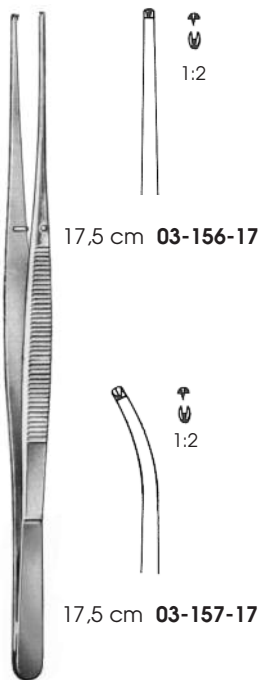

Taylor

17,5 cm **03-156-17**

17,5 cm **03-157-17**

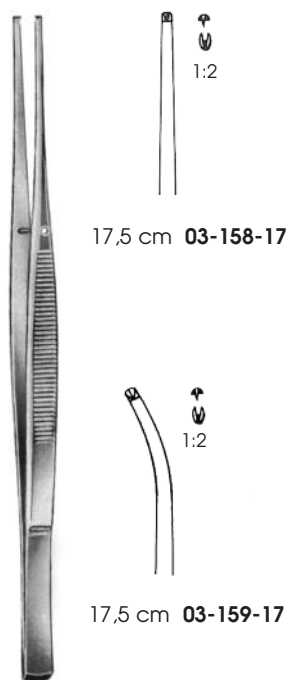

Taylor

17,5 cm **03-158-17**

17,5 cm **03-159-17**



Mikro-Pinzette

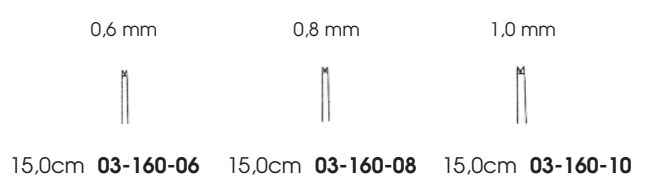

15,0cm **03-160-06**

15,0cm **03-160-08**

15,0cm **03-160-10**



Taylor, Bajonett
 17,0 cm **03-161-17**



Potts-Smith
 18,0 cm **03-164-18**
 21,0 cm **03-164-21**
 25,0 cm **03-164-25**
 30,0 cm **03-164-30**



Potts-Smith
 18,0 cm **03-165-18**
 21,0 cm **03-165-21**
 25,0 cm **03-165-25**
 30,0 cm **03-165-30**



Cushing



Brophy

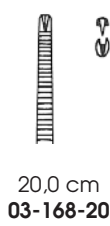

Gerald

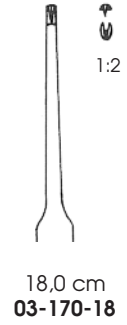



Adlerkreuz

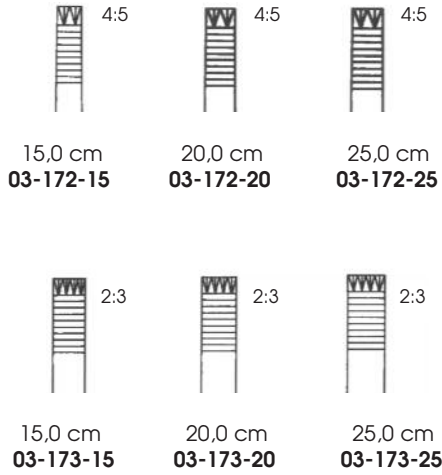

Bonney



Ferris-Smith

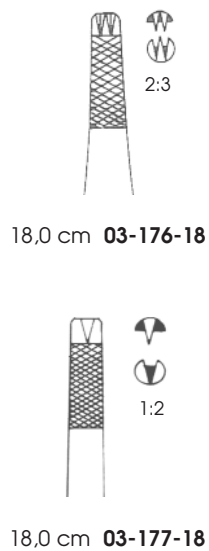

Lane

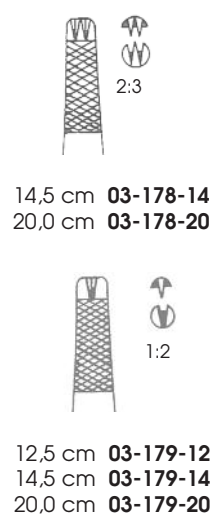

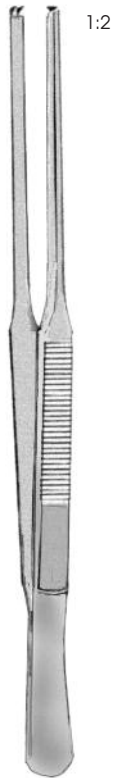

1:2

Duehrssen,
 20,0 cm **03-180-01**

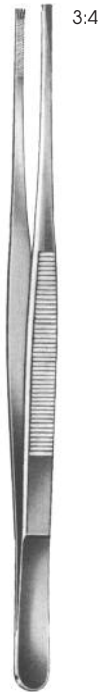

3:4

Stille-Barraya
 18,0 cm **03-182-18**
 20,0 cm **03-182-20**
 23,0 cm **03-182-23**
 25,0 cm **03-182-25**



7:6

Nelson
 23,0 cm **03-183-23**

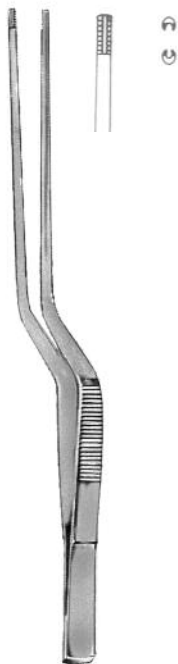

Taylor-Brown
 17,0 cm **03-185-17**



Cushing-Brown
 17,0 cm **03-186-17**

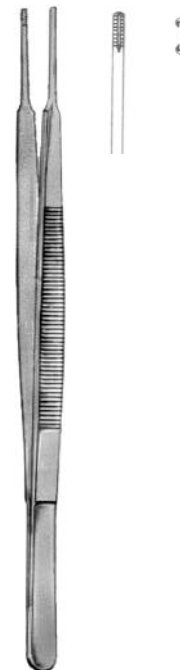

Gerald-Brown
 17,0 cm **03-187-17**



Brown
 15,0 cm **03-188-15**
 20,0 cm **03-188-20**
 25,0 cm **03-188-25**



Adson-Brown
12,0 cm **03-190-12**



Adson-Brown
12,0 cm **03-191-12**
15,0 cm **03-191-15**

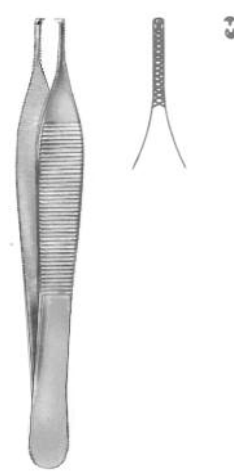

Adson
12,0 cm **03-192-12**

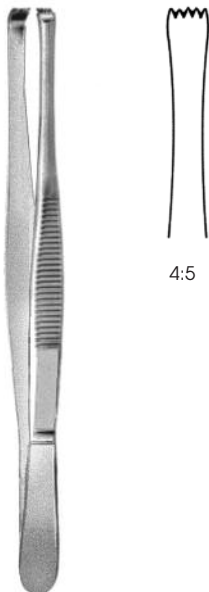

Stone
13,0 cm **03-194-13**
15,0 cm **03-194-15**

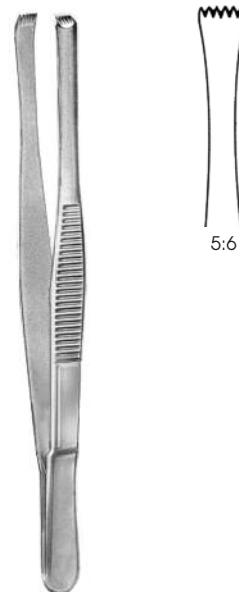

Lerche
15,0 cm **03-196-15**



De Bakey

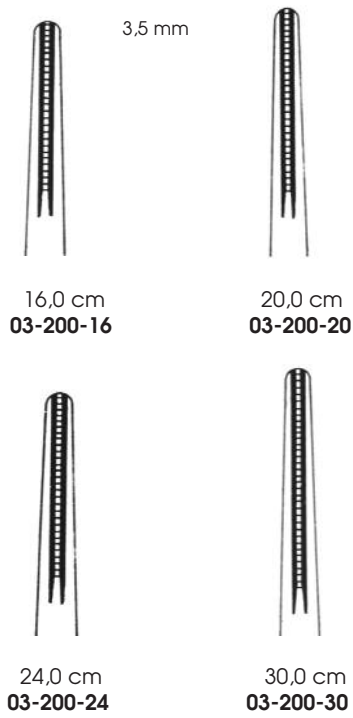

De Bakey

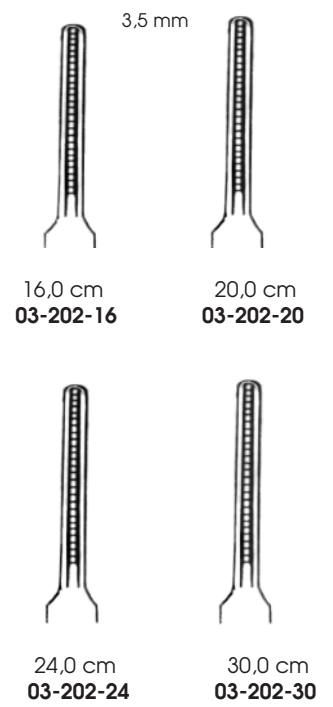

De Bakey

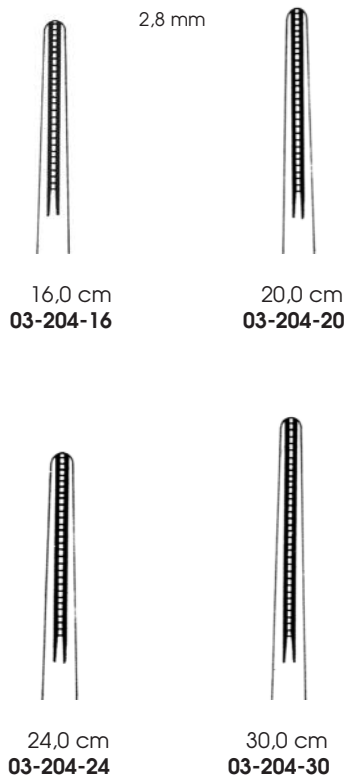

De Bakey

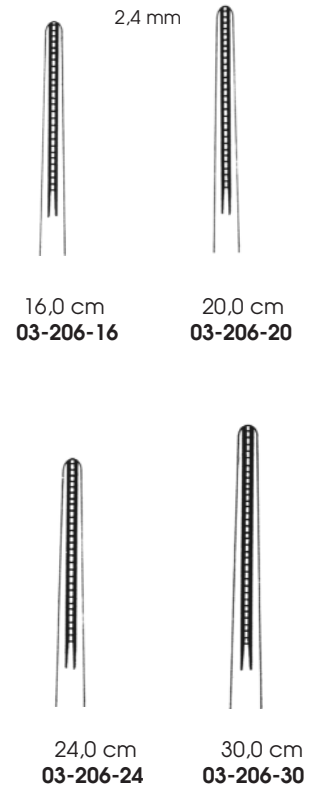

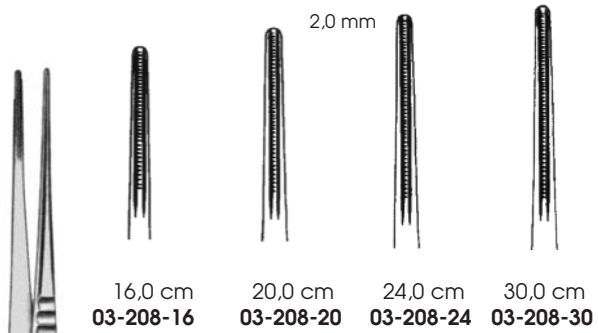

De Bakey

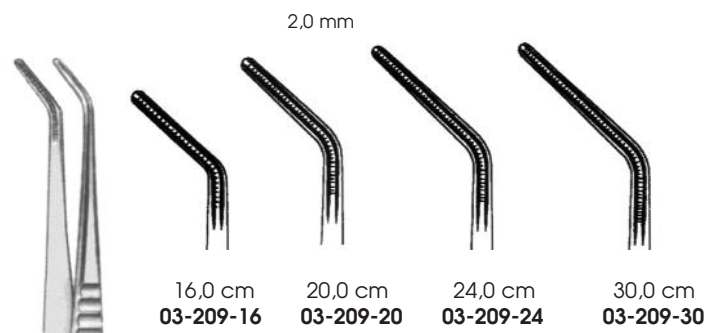

De Bakey

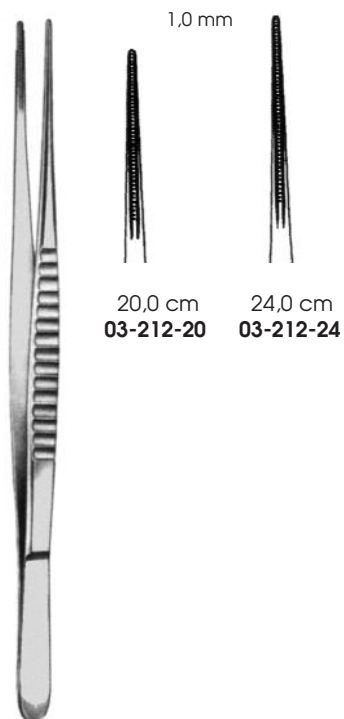
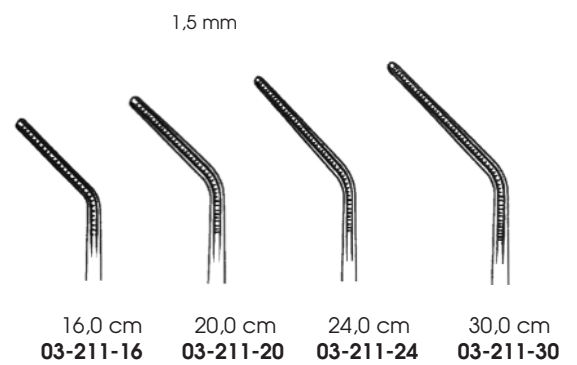
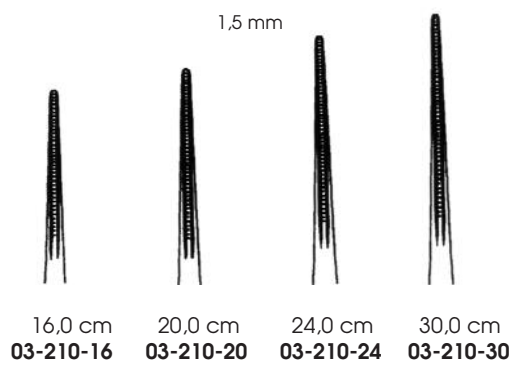

De Bakey

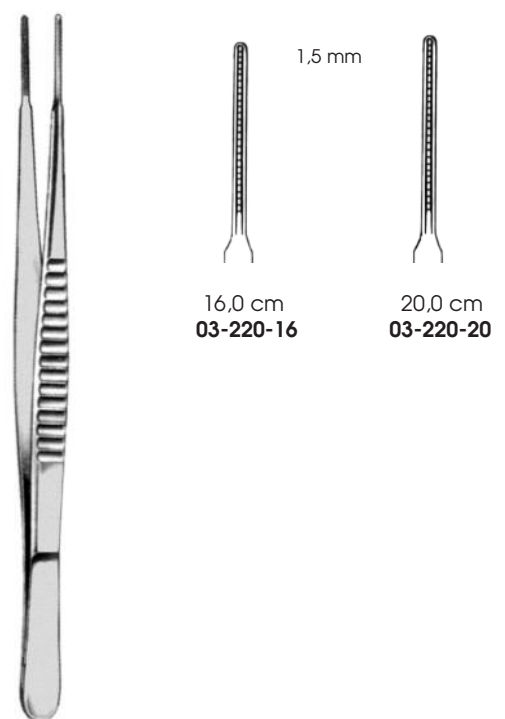

Cooley



Trölsch



11,0 cm **03-401-11**
 12,0 cm **03-401-12**
 15,0 cm **03-401-15**
 18,0 cm **03-401-18**



15,0 cm **03-403-15**



Trölsch (Wilde)



13,0 cm **03-405-13**



Lucae



13,5 cm **03-407-14**



13,5 cm **03-409-14**



Jansen



16,0 cm **03-411-16**
 18,0 cm **03-411-18**
 20,0 cm **03-411-20**



Gerald
18,0 cm **03-413-18**



Gerald
18,0 cm **03-415-18**



Grünwald-Jansen



20,0 cm **03-417-20**



20,0 cm **03-419-20**



Douglas
 9,0 cm **03-500-09**



Shaaf
 9,0 cm **03-502-09**



Beer
 9,0 cm **03-504-09**



Cilien
 9,0 cm **03-508-09**



Littauer
 9,0 cm **03-510-08**



Barraquer
 10,5 cm **03-511-10**



Splinterpinzette
 Splinter Forceps



- 8,0 cm **03-512-08**
- 9,0 cm **03-512-09**
- 10,0 cm **03-512-10**
- 11,0 cm **03-512-11**
- 12,0 cm **03-512-12**
- 14,0 cm **03-512-14**



- 8,0 cm **03-513-08**
- 9,0 cm **03-513-09**
- 10,0 cm **03-513-10**
- 11,0 cm **03-513-11**
- 12,0 cm **03-513-12**
- 14,0 cm **03-513-14**



8,0 cm **03-514-08**
9,0 cm **03-514-09**
10,0 cm **03-514-10**
11,0 cm **03-514-11**
12,0 cm **03-514-12**
14,0 cm **03-514-14**



8,0 cm **03-515-08**
9,0 cm **03-515-09**
10,0 cm **03-515-10**
11,0 cm **03-515-11**
12,0 cm **03-515-12**
14,0 cm **03-515-14**



10,0 cm **03-516-10**



10,0 cm **03-517-10**



10,0 cm **03-518-10**

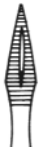

10,0 cm **03-519-10**

Splitterpinzette
Splinter Forceps

Carmalt

Hunter



Feilchenfeld

Uhrmacherpinzetten

Uhrmacherpinzetten

Uhrmacherpinzetten

Splitterpinzette mit Lupe
Splinter Forceps with magnifying glass

7,5 cm **03-522-07**
9,0 cm **03-522-09**
11,5 cm **03-522-11**

11,0 cm **03-524-11**

12,0 cm **03-524-12**

12,0 cm **03-525-12**

12,0 cm **03-528-12**



Austin

14,0 cm **03-600-14**
 18,0 cm **03-600-18**

0,8 mm



Lazar

0,8 mm



15,0 cm
03-602-15

0,5 mm



15,0 cm
03-603-15

0,5 mm



18,0 cm
03-604-18

0,3 mm



12,0 cm **03-606-12**

0,3 mm



13,0 cm **03-608-13**

0,3 mm



13,0 cm **03-609-13**



Vise



0,6 mm



18,0 cm **03-306-18**
23,0 cm **03-306-23**

0,6 mm



18,0 cm **03-307-18**
23,0 cm **03-307-23**

Knüpfpinzette
Suture Tying Forceps



0,3 mm



12,0 cm **03-304-12**
15,0 cm **03-304-15**

0,3 mm



12,0 cm **03-305-12**
15,0 cm **03-305-15**

Knüpfpinzette
Suture Tying Forceps



9,0 cm **03-614-09**
11,0 cm **03-614-11**

Mikro-Knüpfpinzette
Micro Suture Tying Forceps

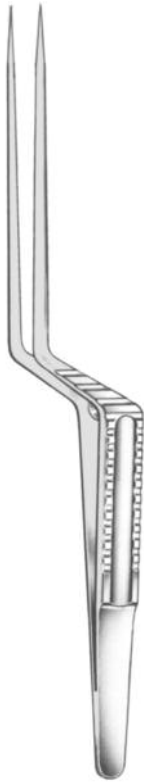

Hunt, bajonett



18,0 cm **03-620-01**

18,0 cm **03-620-02**

18,0 cm **03-620-03**



Yasargil, bajonett

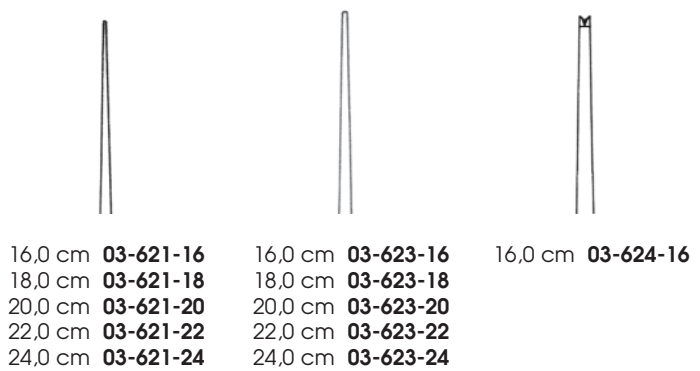

16,0 cm **03-621-16**
 18,0 cm **03-621-18**
 20,0 cm **03-621-20**
 22,0 cm **03-621-22**
 24,0 cm **03-621-24**

16,0 cm **03-623-16**
 18,0 cm **03-623-18**
 20,0 cm **03-623-20**
 22,0 cm **03-623-22**
 24,0 cm **03-623-24**

16,0 cm **03-624-16**



Ø 3 mm
⊙
24,0 cm **03-625-24**

Ø 5 mm
⊙
24,0 cm **03-627-24**

Ø 7 mm
⊙
24,0 cm **03-629-24**

Yasargil-Samii



Ø 3 mm
⊙
22,0 cm **03-631-22**

Ø 5 mm
⊙
22,0 cm **03-633-22**

Ø 3 mm
⊙
22,0 cm **03-635-22**

Ø 5 mm
⊙
22,0 cm **03-637-22**

Yasargil



Ø 3 mm
⊙
22,0 cm **03-639-22**

Ø 5 mm
⊙
22,0 cm **03-641-22**

Heifetz



Samii

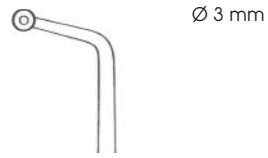

23,0 cm **03-643-23**



23,0 cm **03-649-23**

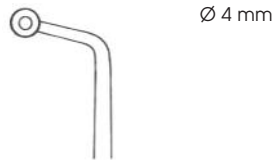

23,0 cm **03-645-23**



23,0 cm **03-651-23**

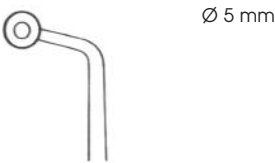

23,0 cm **03-647-23**



23,0 cm **03-653-23**

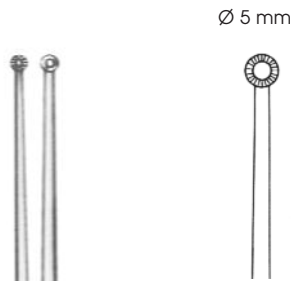

Hunt
 20,0 cm **03-655-20**



Yasargil
 20,0 cm **03-657-20**

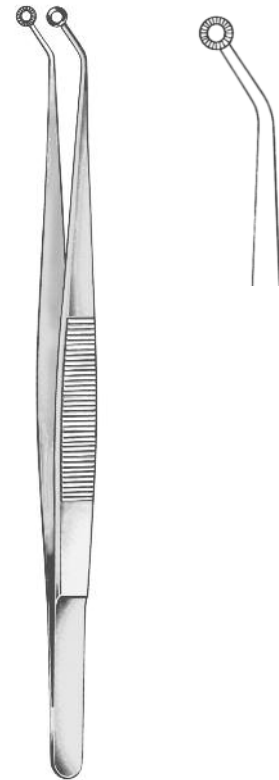

Hunt
 20,0 cm **03-659-20**