

23

**Herz-Gefäß**  
Cardiovascular

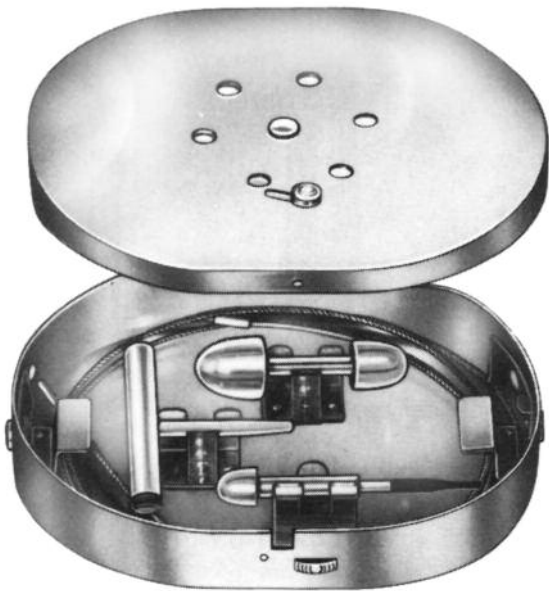

**Nabatoff**  
komplet/complete  
135x100x25 mm **23-010-00**

**Metalowe etui** **23-010-09**  
Metal case, only

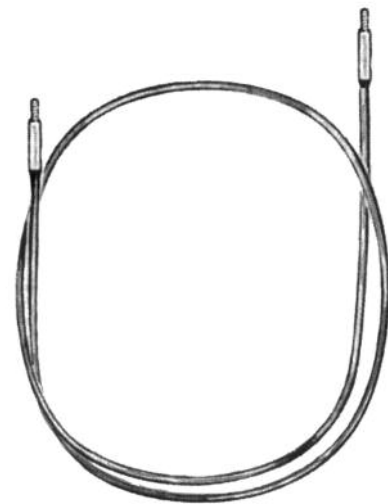

**Linka**  
Traction Cable  
90 cm **23-010-01**



**Koncowka  
plastikowa**  
Plastic Probe Tip  
**23-010-02**



**Koncowka  
metalowa**  
Metal Probe Tip  
**23-010-03**



Ø 6,0 mm  
**23-010-04**



Ø 9,0 mm  
**23-010-05**



Ø 12,0 mm  
**23-010-06**



Ø 15,0 mm  
**23-010-07**

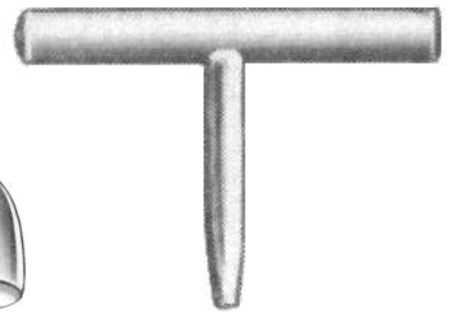

**Uchwyt/Handle**  
**23-010-08**



**23-011-00**, 11,0 cm

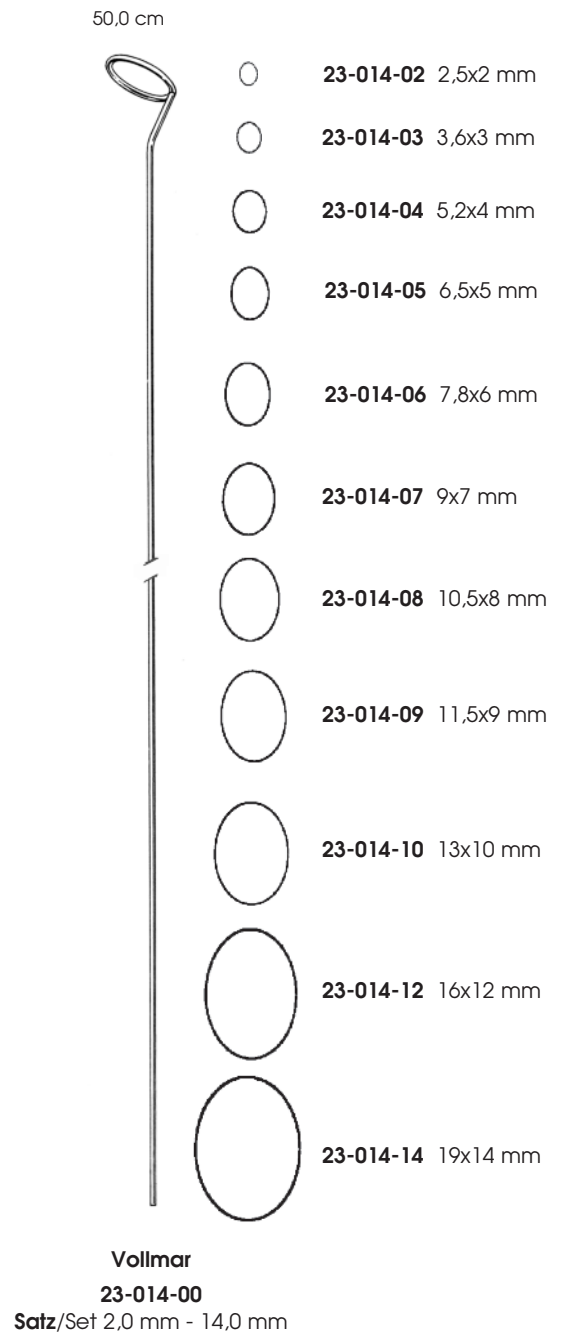
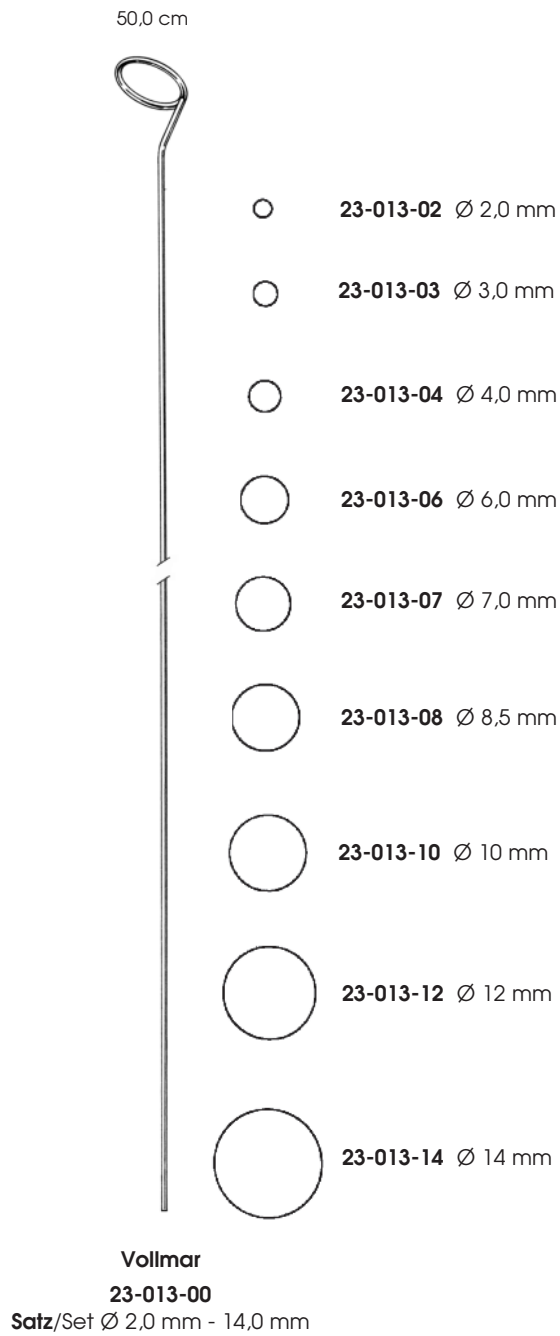

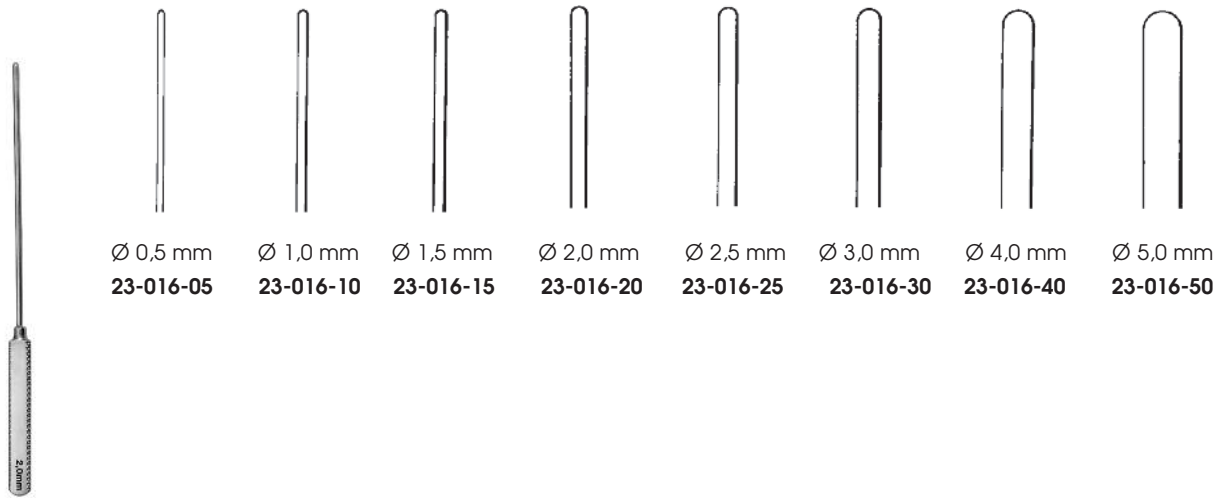

Cooley, 13,0 cm

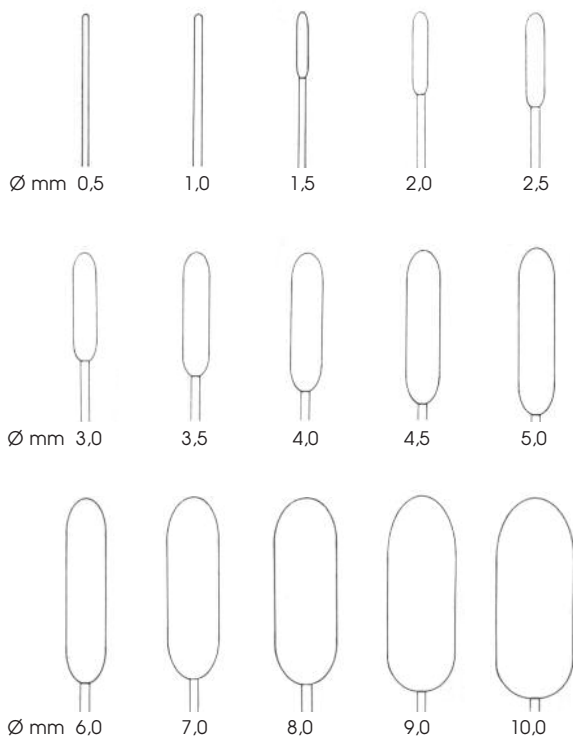

19,0 cm	35,0 cm	Ø mm
23-018-05	23-019-05	0,5
23-018-10	23-019-10	1,0
23-018-15	23-019-15	1,5
23-018-20	23-019-20	2,0
23-018-25	23-019-25	2,5
23-018-30	23-019-30	3,0
23-018-35	23-019-35	3,5
23-018-40	23-019-40	4,0
23-018-45	23-019-45	4,5
23-018-50	23-019-50	5,0
23-018-60	23-019-60	6,0
23-018-70	23-019-70	7,0
23-018-80	23-019-80	8,0
23-018-90	23-019-90	9,0
23-018-99	23-019-99	10,0



De Bakey

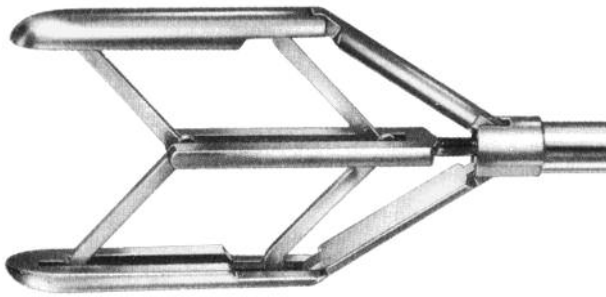

**Spreizweite 8 - 42 mm**  
Blade opening 8 - 42 mm

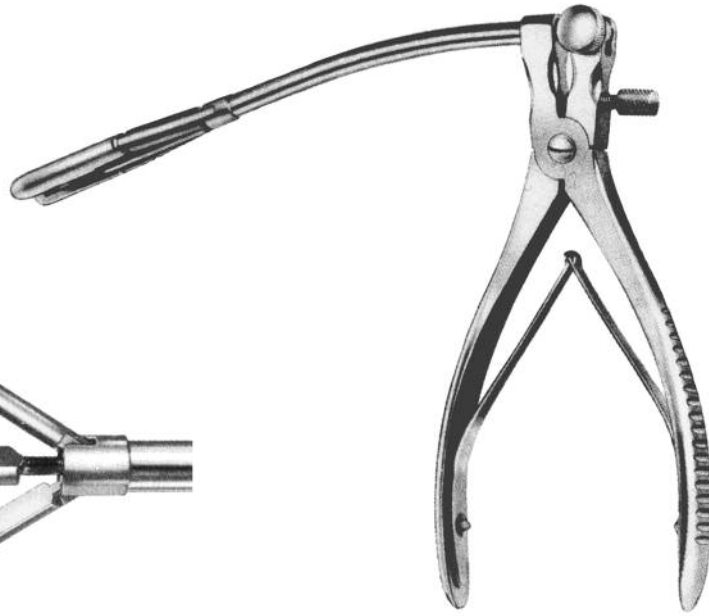

**Tubbs**  
23-030-00



**Spreizweite 8 - 15 mm**  
Blade opening 8 - 15 mm

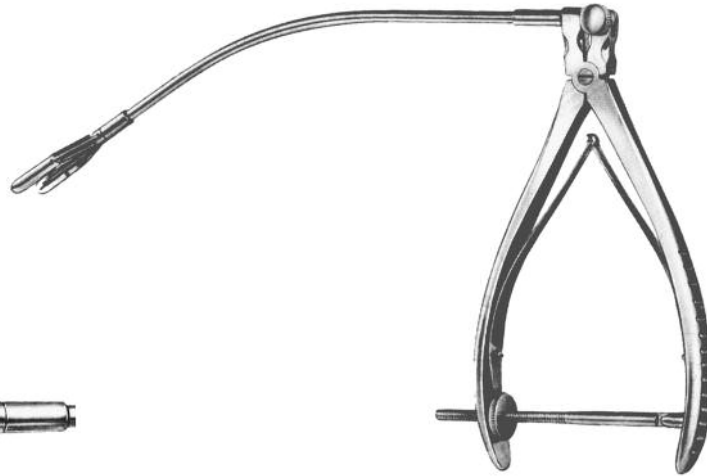

**Cooley**  
23-032-00

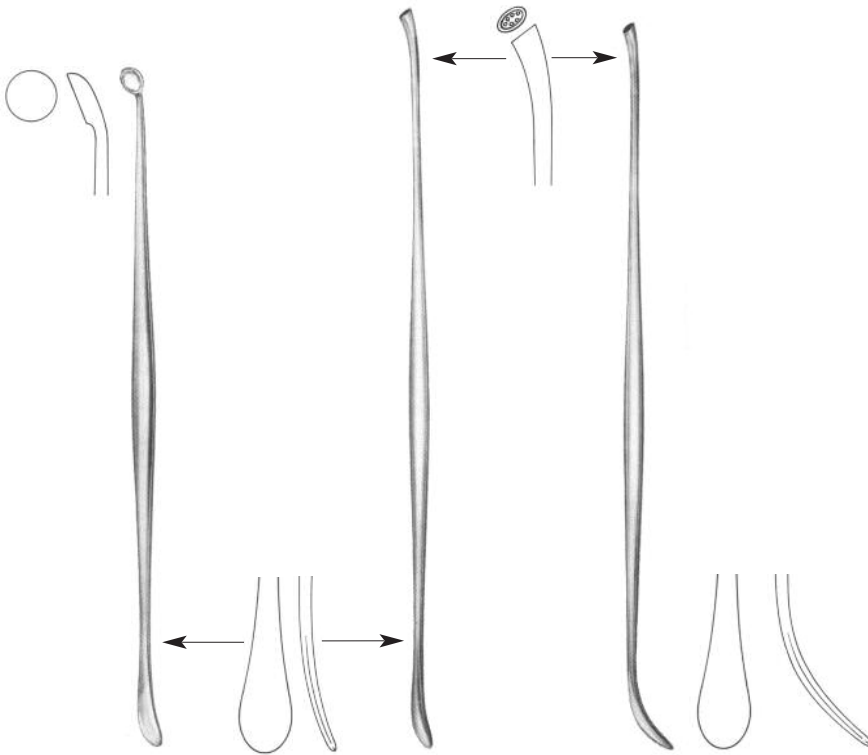

**Penfield, Fig. 1**  
17,5 cm **23-100-01**

**Penfield, Fig. 2**  
19,5 cm **23-100-02**

**Penfield, Fig. 3**  
19,5 cm **23-100-03**



**Penfield, Fig. 4**  
21,5 cm **23-100-04**



**Penfield, Fig. 5**  
29,0 cm **23-100-05**



**Halle**  
 18,0 cm **23-102-18**



23,0 cm **23-104-23**



**Freer**  
 18,0 cm **23-105-18**



18,5 cm **23-107-18**  
 21,5 cm **23-107-21**



**Schmid**



14,0 cm, 4 mm  
**23-108-14**



23,0 cm, 6 mm  
**23-108-23**

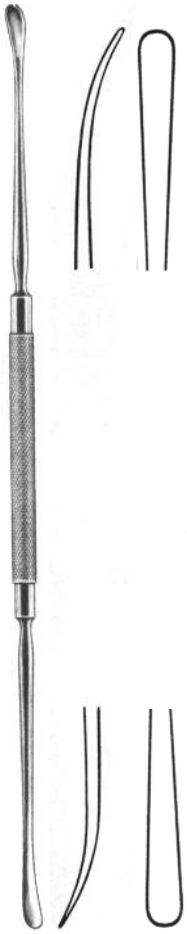

**Davis**  
24,5 cm **23-109-24**

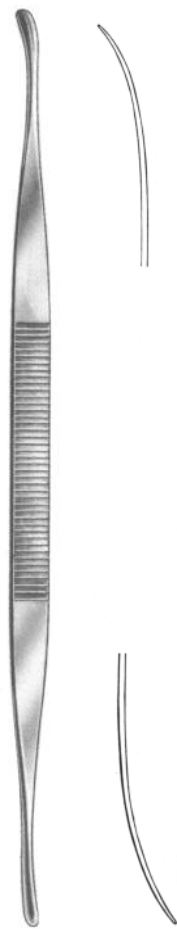

**Tönnis**

3/5 mm  
**23-111-01**

4/6 mm  
**23-111-02**



**Robb**  
Fig. 1  
2,5/5,0 mm  
**23-113-01**



**Robb**  
Fig. 2  
2,0/4,0 mm  
**23-113-02**



**Robb**  
Fig. 3  
1,5/3,0 mm  
**23-113-03**



**Robb**  
Fig. 4  
1,5/2,0 mm  
**23-113-04**



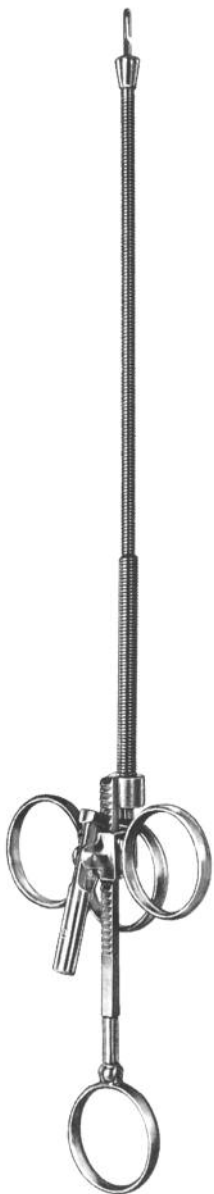

**Rumel-Belmont, 32,0 cm**  
 Ø 3,2 mm **23-130-32**  
 Ø 4,0 mm **23-130-40**  
 Ø 6,4 mm **23-130-64**



**Fadenfänger, 26,0 cm**

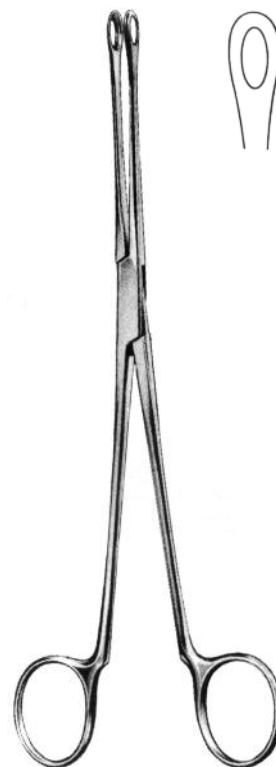
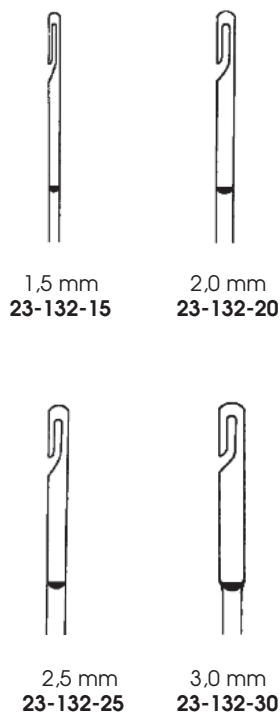

**Blake**  
 20,5 cm **23-140-20**



**Blake**  
 20,5 cm **23-141-20**



**Cooley**  
**rechts/right**  
45x48 mm  
24,5 cm **23-200-24**

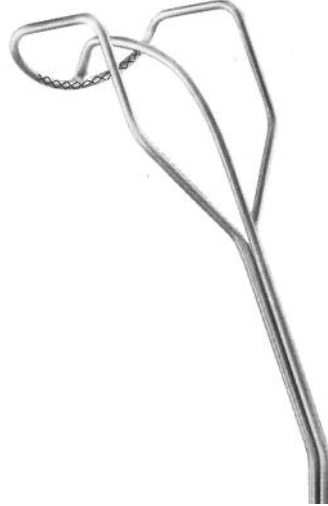

**Cooley**  
**rechts, gezahnt/right, serrated**  
45x48 mm  
24,5 cm **23-201-24**



**Cooley**  
**links/left**  
45x48 mm  
25,5 cm **23-202-25**

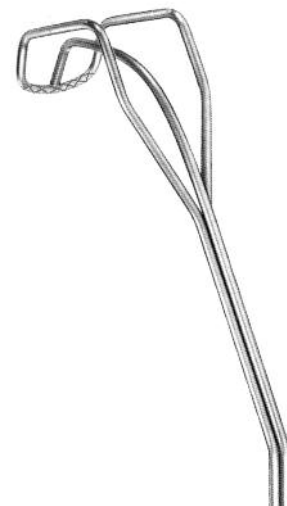

**Cooley**  
**rechts, gezahnt/right, serrated**  
24,0 cm 45x30 mm **23-203-24**  
24,0 cm 45x35 mm **23-204-24**



**Cooley**

12,0 cm **23-600-12**  
 18,0 cm **23-600-18**



13,5 cm **23-604-13**  
 15,5 cm **23-606-15**  
 18,0 cm **23-608-18**  
 20,0 cm **23-610-20**



**23-611-21**



**Landolt**  
**23-613-25**



**23-615-21**



**Griff mit Spannfutter**  
Handle with chuck  
10,5 cm **23-650-00**



**23-650-01**  
9,5 cm



**23-650-02**  
8,5 cm

**auswechselbar**  
interchangeable



**Biemer Gefäßspreizer**  
Vessel Spreader  
16,0 cm **23-660-16**



**Gefäßdilator**  
Vessel Dilator  
12,5 cm



Ø 0,5 mm  
**23-663-05**



Ø 1,0 mm  
**23-663-10**



Ø 1,5 mm  
**23-663-15**



**Jacobson Knopfsonde**  
Probe with ball tip  
18,5 cm



**23-664-18**



**23-665-18**

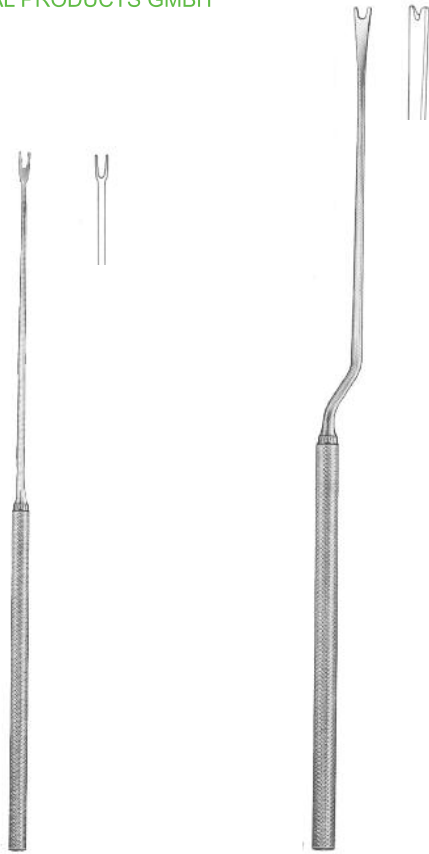

**Jacobson**  
 Fadengabel/Suture Pusher  
 18,5 cm **23-666-18**

**Caspar**  
 Fadengabel/Suture Pusher  
 23,0 cm **23-667-23**

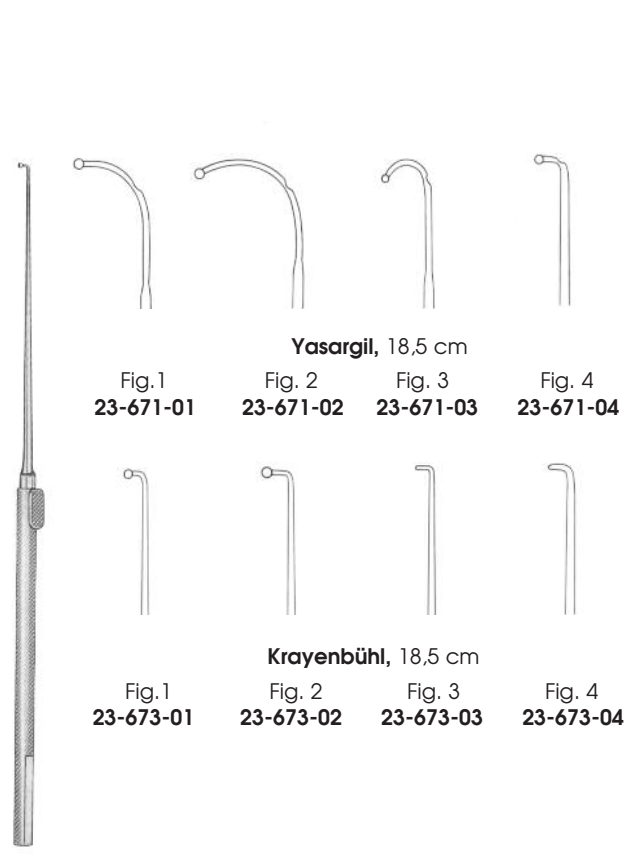

**Yasargil, 18,5 cm**  
 Fig. 1 **23-671-01** Fig. 2 **23-671-02** Fig. 3 **23-671-03** Fig. 4 **23-671-04**

**Krayenbühl, 18,5 cm**  
 Fig. 1 **23-673-01** Fig. 2 **23-673-02** Fig. 3 **23-673-03** Fig. 4 **23-673-04**

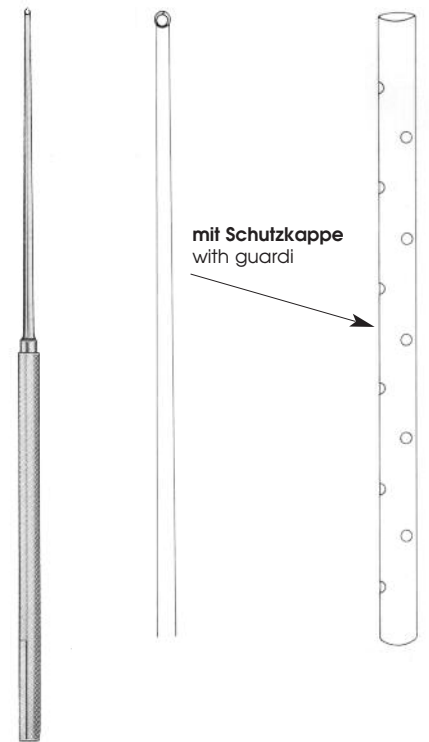

**Gewebekralle**  
 Tissue Picks  
 Ø 1,8 mm  
 18,5 cm **23-674-18**

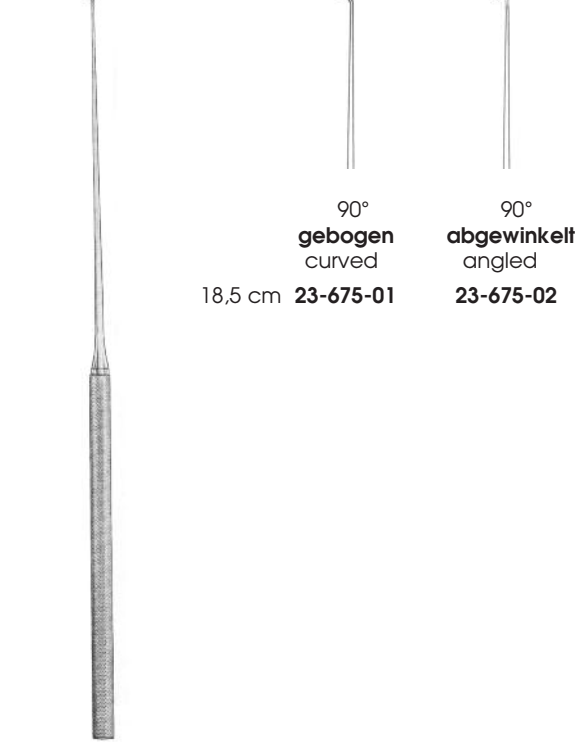

**Scharfes Häkchen**  
 Sharp Hook

90° **gebogen** curved  
 18,5 cm **23-675-01**  
 90° **abgewinkelt** angled  
**23-675-02**

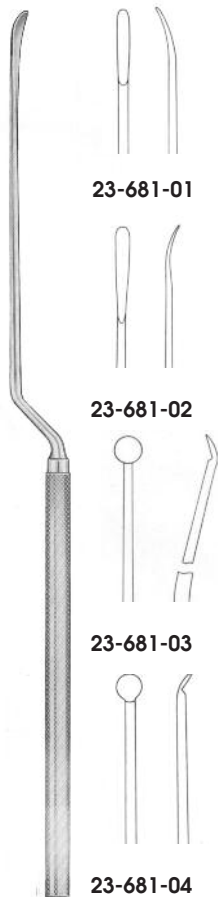

**Mikro Dissektor**  
Micro Dissector  
23,0 cm

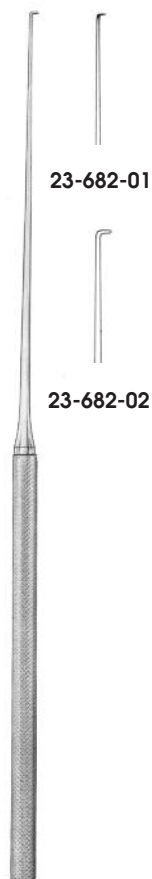

**Mikro Häkchen**  
Micro Hook  
23,0 cm



**Mikro Dissektor**  
Micro Dissector  
23,0 cm

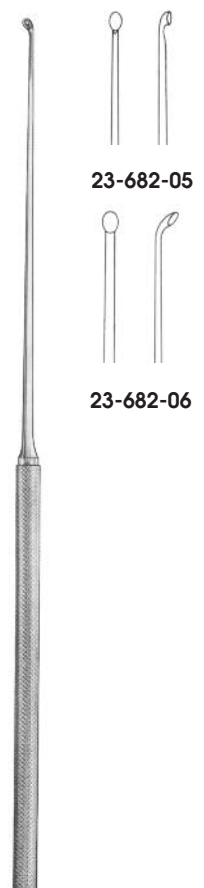

**Mikro Löffel**  
Micro Scoop  
23,0 cm

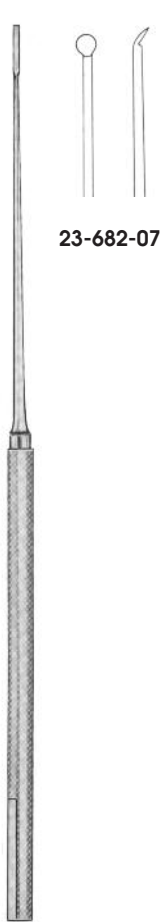

23-682-07

**Mikro Raspatorium**  
 Micro Raspatory  
 23,0 cm  
 plattenförmig  
 round blade

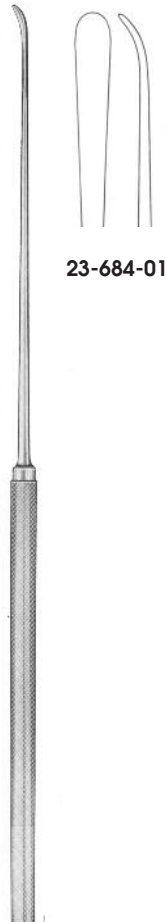

23-684-01

**Mikro Dissektor**  
 Micro Dissector  
 23,0 cm  
 gebogen, 4,5 mm  
 curved, 4,5 mm



21,0 cm

**23-685-01**  
 aufgebogen  
 up-curved  
 1,0 mm

**Mikro Dissektor**  
 Micro Dissector



23,0 cm

**23-684-02**  
 abgebogen/  
 down-curved  
 4,5 mm



**23-684-03**  
 down-curved  
 2,0 mm

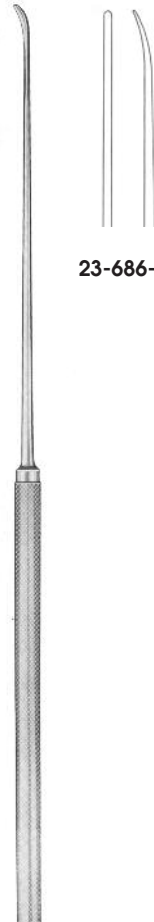

23-686-01

**Mikro Dissektor**  
 Micro Dissector  
 20,0 cm  
 gebogen, 1,0mm  
 curved, 1,0mm



**Explorations- und Koagulationshäkchen**  
Exploration- and Coagulation Hook  
24,5 cm

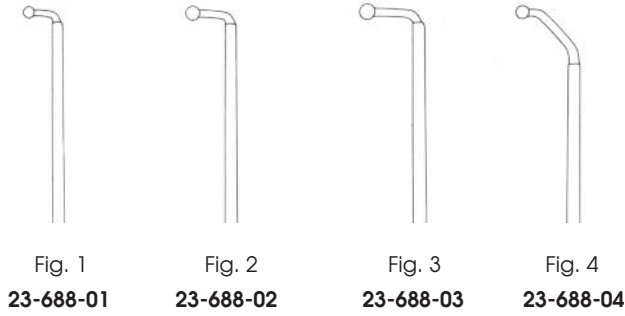
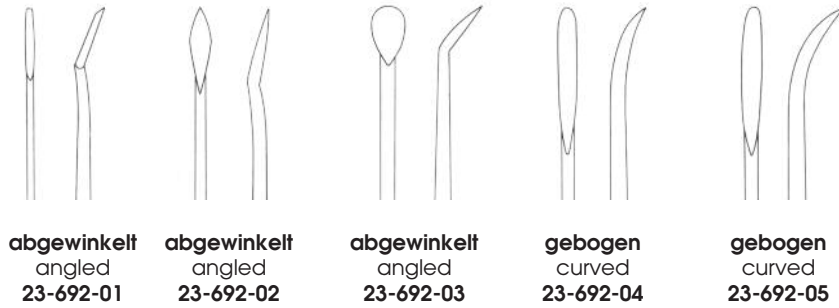

Fig. 1 23-688-01  
Fig. 2 23-688-02  
Fig. 3 23-688-03  
Fig. 4 23-688-04

**geknöpft, isoliert**  
probe-end, insulated



**Yasargil Mikro-Raspatorium**  
Micro Raspatorium  
18,5 cm



abgewinkelt angled 23-692-01  
abgewinkelt angled 23-692-02  
abgewinkelt angled 23-692-03  
gebogen curved 23-692-04  
gebogen curved 23-692-05

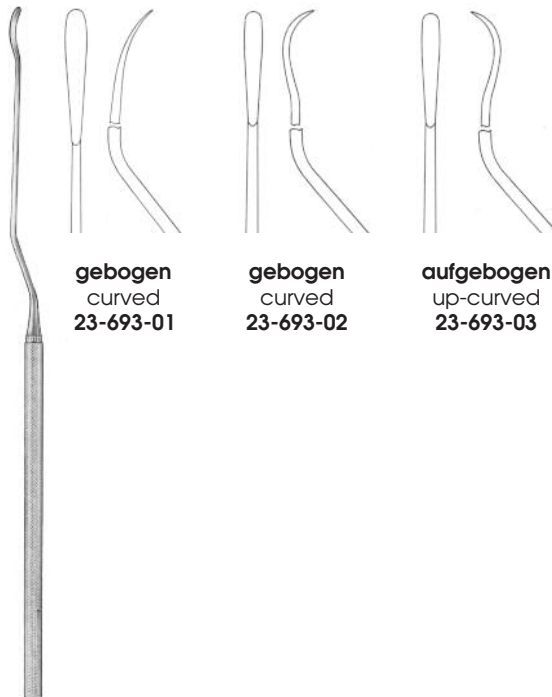

gebogen curved 23-693-01  
gebogen curved 23-693-02  
aufgebogen up-curved 23-693-03

**Yasargil Mikro-Raspatorium**  
Micro Raspatorium  
18,5 cm



**Yasargil scharfer Mikro-Löffel**  
Micro Scoop  
18,5 cm 23-693-04





1,0 mm

20,0 cm **23-694-10**  
 23,0 cm **23-695-10**



1,5 mm

**23-694-15**  
**23-695-15**



2,0 mm

**23-694-20**  
**23-695-20**

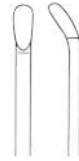

2,5 mm

**23-694-25**  
**23-695-25**



3,0 mm

20,0 cm **23-694-30**  
 23,0 cm **23-695-30**

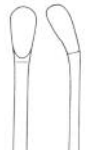

3,5 mm

**23-694-35**  
**23-695-35**



4,0 mm

**23-694-40**  
**23-695-40**



5,0 mm

**23-694-50**  
**23-695-50**

**Samii Tumormesser**  
 Tumor Knife



1,5 mm

20,0 cm **23-696-15**  
 23,0 cm **23-697-15**



3,0 mm

**23-696-30**  
**23-697-30**



4,5 mm

**23-696-45**  
**23-697-45**



6,0 mm

**23-696-60**  
**23-697-60**



1,8 mm

23,0 cm **23-698-18**



2,5 mm

**23-698-25**



**Samii Tumormesser**  
 Tumor Knife



**Jakobson Mikro-Gefäßmesser**  
Micro Vessel Knife  
18,5 cm **23-699-01**



**Koos Mikro- Gefäßmesser**  
Micro Vessel Knife  
18,5 cm



**aufgebogen**  
up-curved  
**23-699-02**



**abgebogen**  
down-curved  
**23-699-03**



**aufgebogen**  
up-curved  
**23-699-04**



**abgebogen**  
down-curved  
**23-699-05**



**abgebogen**  
down-curved  
**23-699-06**



**aufgebogen**  
up-curved  
**23-699-07**



**abgebogen**  
down-curved  
**23-699-08**



**aufgebogen**  
up-curved  
**23-699-09**



**Kraus Mikro-Gefäßmesser**  
Micro Vessel Knife  
18,5 cm **23-699-10**

