



17

H N O - Instrumente
E N T - Instruments



Brünings
19,0 cm 17-006-19

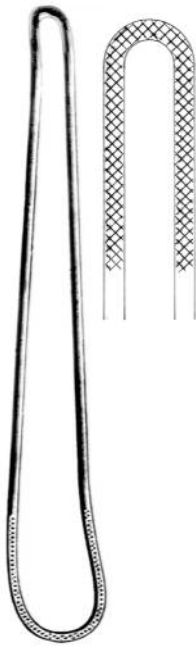

Frenzel
16,5 cm 17-007-16



Hartmann
15,0 cm 17-011-15

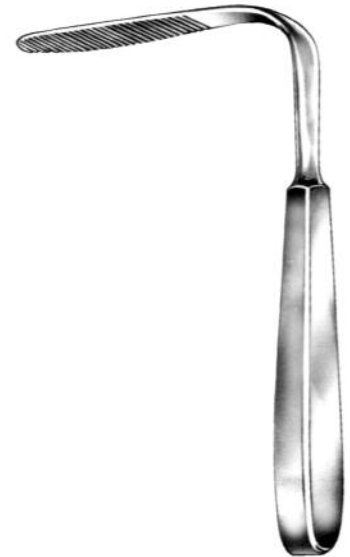

Tobald
16,0 cm 17-013-16



17-017-01



17-017-02

Weder, 15,0 cm



Heister
13,0 cm 17-022-13



Molt
10,0 cm 17-023-10

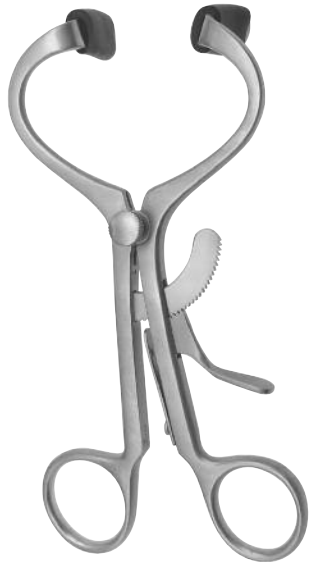

Doyen-Jansen
 14,0 cm 17-026-14



Denhardt
 12,0 cm 17-028-12

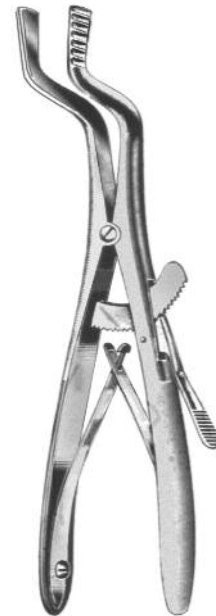

Roser-König
 16,0 cm 17-029-16
 19,0 cm 17-029-19

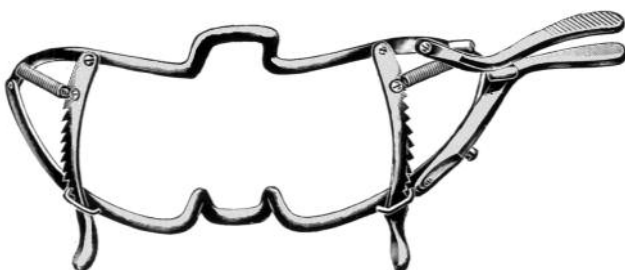

Whitehead
 11,0 cm 17-031-11
 13,0 cm 17-031-13
 15,0 cm 17-031-15

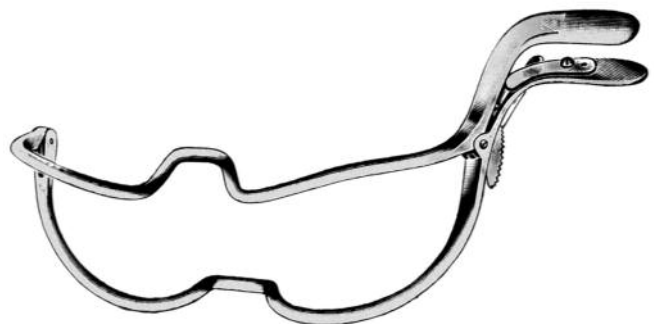

Whitehead-Jennings
 9,0 cm 17-033-09
 11,0 cm 17-033-11
 13,0 cm 17-033-13
 15,0 cm 17-033-15



Dingmann, komplett/complete
17-035-00

bestehend aus/consisting of:

- 2 drehbare Wangenhalter**
2 rotating cheek holders
- 2 bewegliche Zahnhaken und Fadenführer**
2 movable tooth hooks and thread guide
- je 1 Zungenspatel Dingmann 17-056-01,-02,-03**
each 1 Tongue blade Dingmann 17-056-01,-02,-03

Dingmann, Griff allein/Handle only
17-035-01



Davis-Boyle

- 17-041-00 Erwachsene/adult**
- 17-042-00 Kleinkinder/infant**
- 17-043-00 Kinder/children**



Kilner-Doughty

17-044-19



McIvor

17-045-00



Russel-Davis

28x 65 mm **17-050-01**
 33x 75 mm **17-050-02**
 37x 80 mm **17-050-03**
 41x 94 mm **17-050-04**
 46x103 mm **17-050-05**



Gast

28x65 mm **17-052-01**
 32x75 mm **17-052-02**
 37x80 mm **17-052-03**

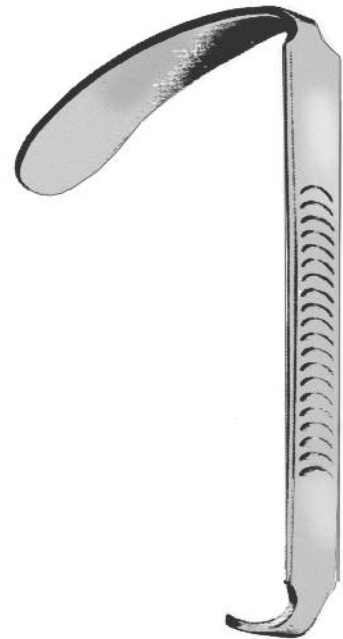

McIvor

23x 70 mm **17-054-01**
 25x 86 mm **17-054-02**
 26x100 mm **17-054-03**

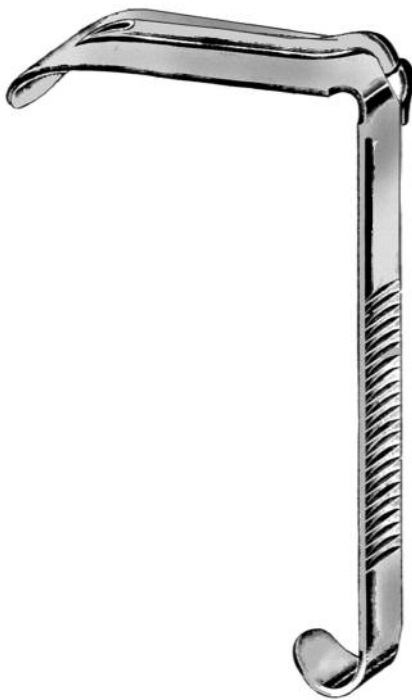

Davis-Boyle

21x 30 mm **17-055-01**
 23x 65 mm **17-055-02*** *mit Ätherrohr
 24x 80 mm **17-055-03*** *with anesthetic tube
 25x 93 mm **17-055-04***
 26x108 mm **17-055-05***

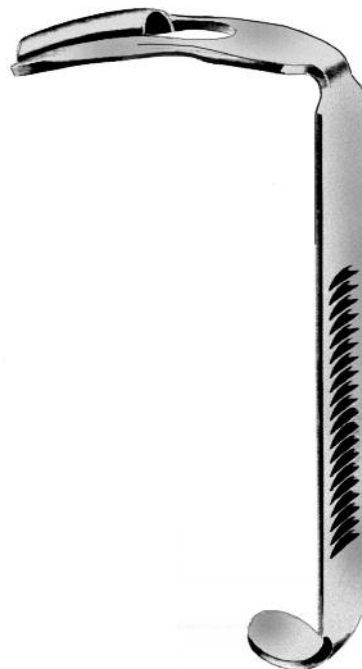

Dingmann

24x62 mm **17-056-01**
 28x65 mm **17-056-02**
 31x75 mm **17-056-03**



Negus
Bruststütze
Chest support
17-060-00



Sternberg
12,0 cm 17-070-12
14,0 cm 17-070-14
16,0 cm 17-070-16



Collin
16,0 cm 17-072-16
18,0 cm 17-072-18

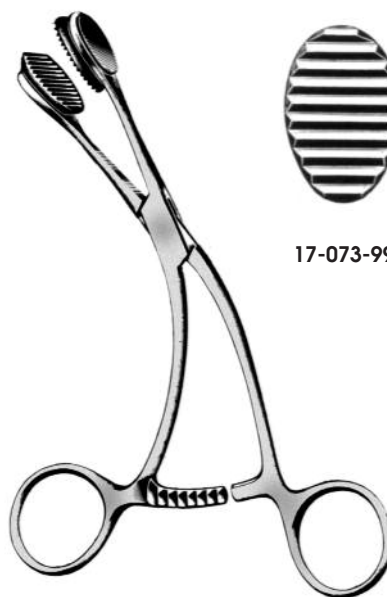

Young
16,0 cm 17-073-16



17-073-99



Bishop
13,0 cm 17-074-13



White
18,0 cm 17-085-18
23,5 cm 17-085-23



Blohmke
20,5 cm 17-093-20



Ballenger
21,5 cm 17-094-21



Marschik
22,0 cm 17-096-22

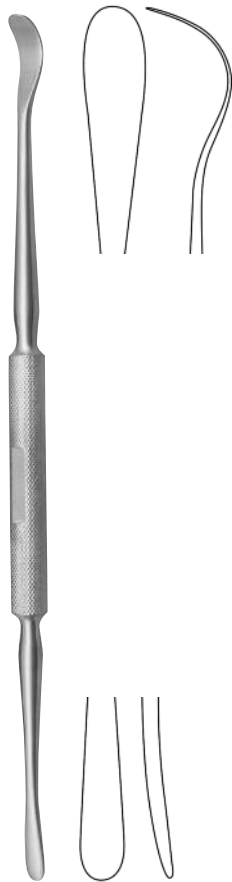

Carpenter
25,0 cm **17-100-01**

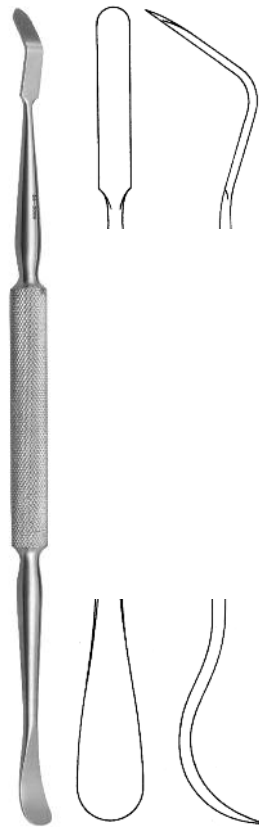

24,0 cm **17-100-02**

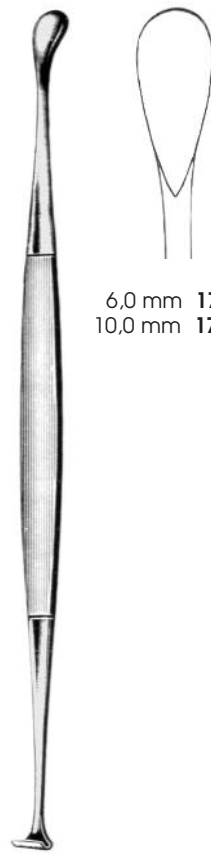

6,0 mm **17-101-01**
10,0 mm **17-101-02**

Hurd, 21,5 cm



10,0 mm **17-102-01**
17,0 mm **17-102-02**

Henke, 23,5 cm



Abraham
 21,5 cm 17-106-21



Brünings
 21,5 cm 17-107-21



Fisher
 20,5 cm 17-109-20



Eves
 25,0 cm 17-150-25 **bez zamka**
 without catch
 25,0 cm 17-152-25 **z zamkiem**
 with catch



Roeder
 26,5 cm 17-153-26



Brünings
 27,0 cm 17-154-27

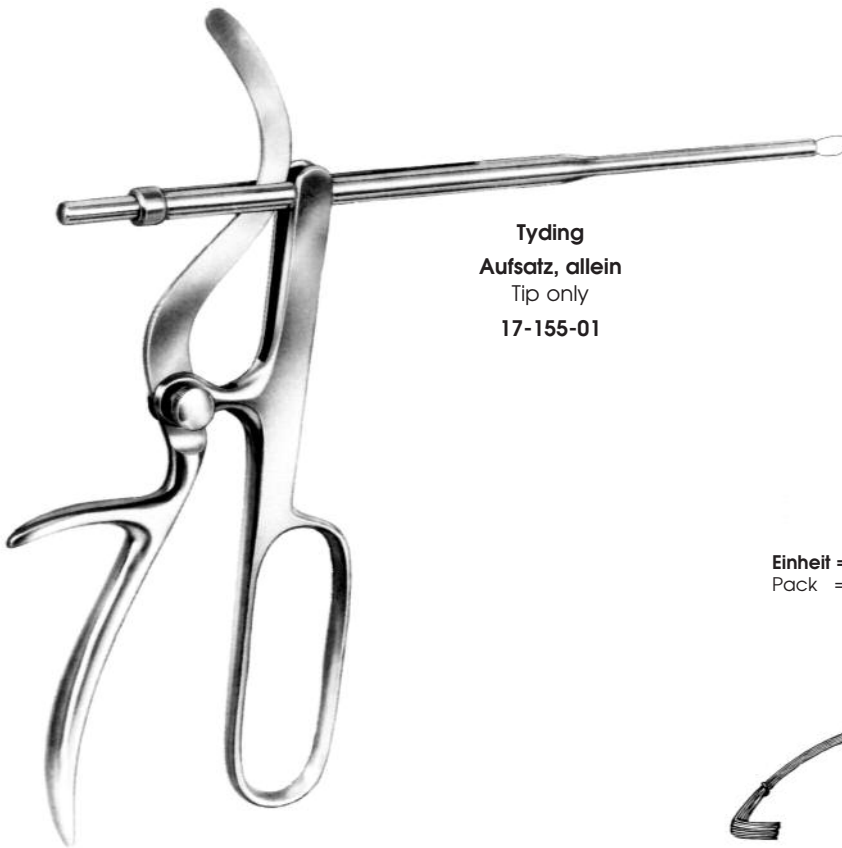

Tyding
Aufsatz, allein
Tip only
17-155-01

Einheit = 12 Stück
Pack = 12 pieces

Einheit = 100 Stück
Pack = 100 pieces



17-156-03 Ø 0,3 mm
17-156-05 Ø 0,5 mm



17-157-04 40,0 mm
17-157-05 50,0 mm

Tyding
mit Aufsatz
with tip
17-155-00

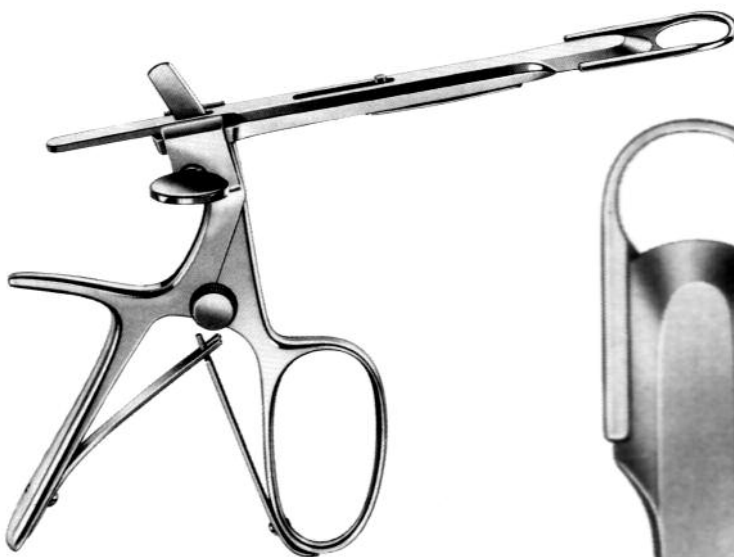

Sluder-Ballenger
komplett mit 3 Aufsätzen
complete with 3 tips
17-159-00
Griff allein
Handle only
17-159-04



Fig. 1
17-159-01



Fig. 2
17-159-02

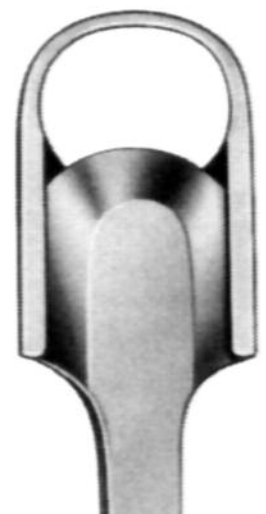
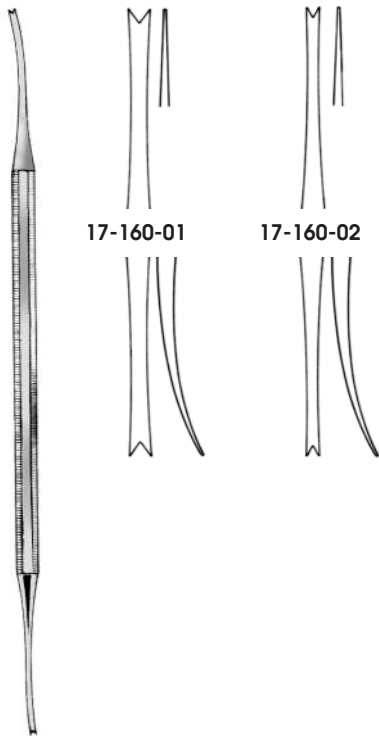

Fig. 3
17-159-03



17-160-01

17-160-02

Luniatschek, 18,0 cm

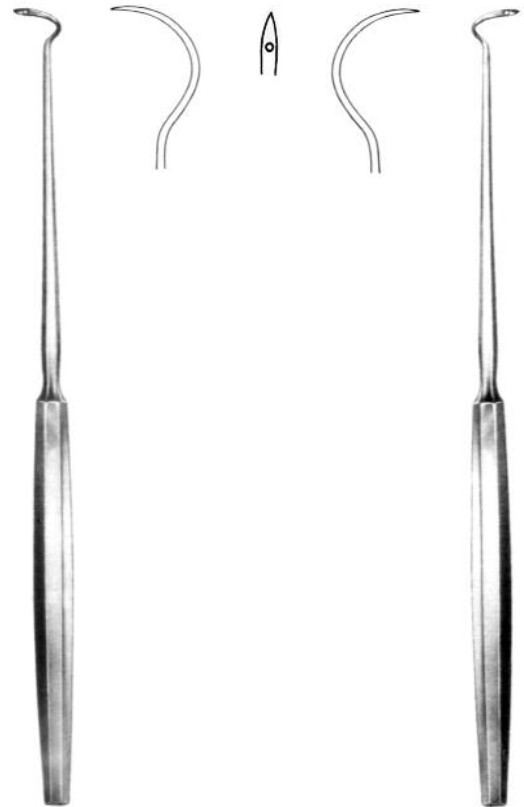

Hurd
 21,0 cm 17-163-21

Hurd
 21,0 cm 17-165-21



Von Eicken
 25,0 cm 17-167-25

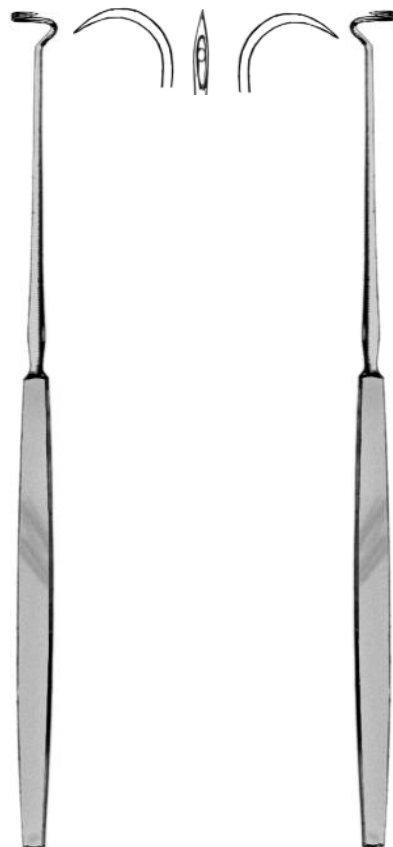

Dupuy Weiss, 22,0 cm
 17-169-22

17-171-22

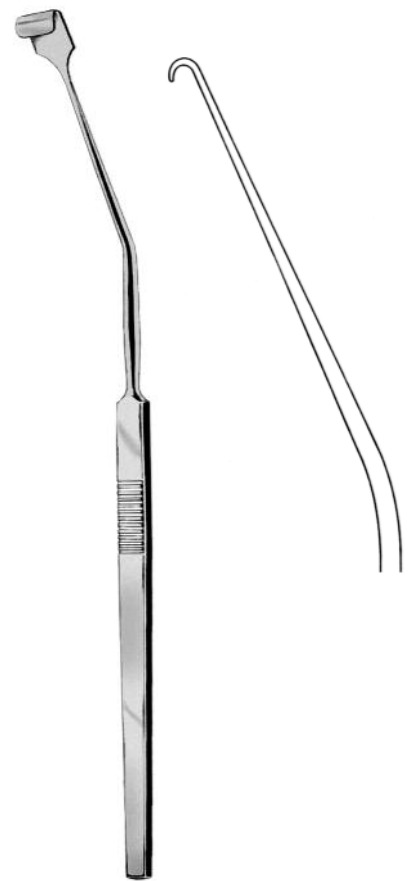

Nager
 23,0 cm 17-175-23



Fig. 1
17-181-01
17-183-01



Fig. 2
17-181-02
17-183-02



Fig. 3
17-181-03
17-183-03



Fig. 4
17-181-04
17-183-04



Fig. 5
17-181-05
17-183-05



Fig. 6
17-181-06
17-183-06



Beckmann, 22,0 cm

17-181-01 - 17-181-06

17-183-01 - 17-183-06



La Force, 23,0 cm
Fig. 1 17-187-01
Fig. 2 17-187-02
Fig. 3 17-187-03

Ersatzklingen, Spare Blades



Fig. 1
17-187-11



Fig. 2
17-187-12



Fig. 3
17-187-13



- 17-200-08
- 17-200-10
- 17-200-12
- 17-200-14
- 17-200-16
- 17-200-18
- 17-200-20
- 17-200-22
- 17-200-24
- 17-200-26
- 17-200-28
- 17-200-30



- Fig. 00 Ø 8,0 mm
- Fig. 0 Ø 10,0 mm
- Fig. 1 Ø 12,0 mm
- Fig. 2 Ø 14,0 mm
- Fig. 3 Ø 16,0 mm
- Fig. 4 Ø 18,0 mm
- Fig. 5 Ø 20,0 mm
- Fig. 6 Ø 22,0 mm
- Fig. 7 Ø 24,0 mm
- Fig. 8 Ø 26,0 mm
- Fig. 9 Ø 28,0 mm
- Fig. 10 Ø 30,0 mm



- 17-210-08
- 17-210-10
- 17-210-12
- 17-210-14
- 17-210-16
- 17-210-18
- 17-210-20
- 17-210-22
- 17-210-24
- 17-210-26
- 17-210-28
- 17-210-30



11,0 cm
 17-201-00



11,0 cm
 17-202-00



Ø 12,0 mm
 17-230-12



Ø 14,0 mm
 17-230-14



Ø 16,0 mm
 17-230-16



Ø 18,0 mm
 17-230-18

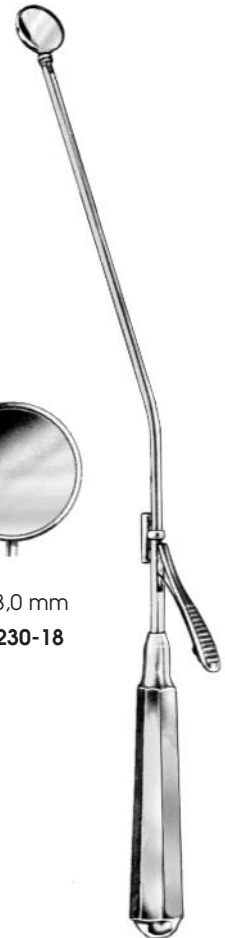

Michel, 25,0 cm
 17-230-12 - 17-230-18



Reichert
23,0 cm 17-241-23

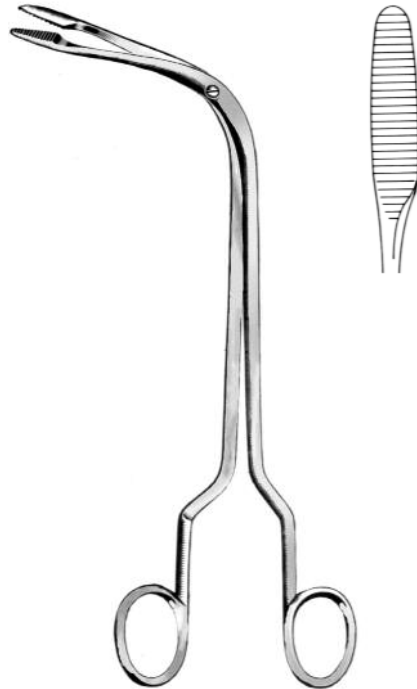

Fränkel
22,0 cm 17-247-22



17-251-01



17-251-02



17-251-03



17-251-04

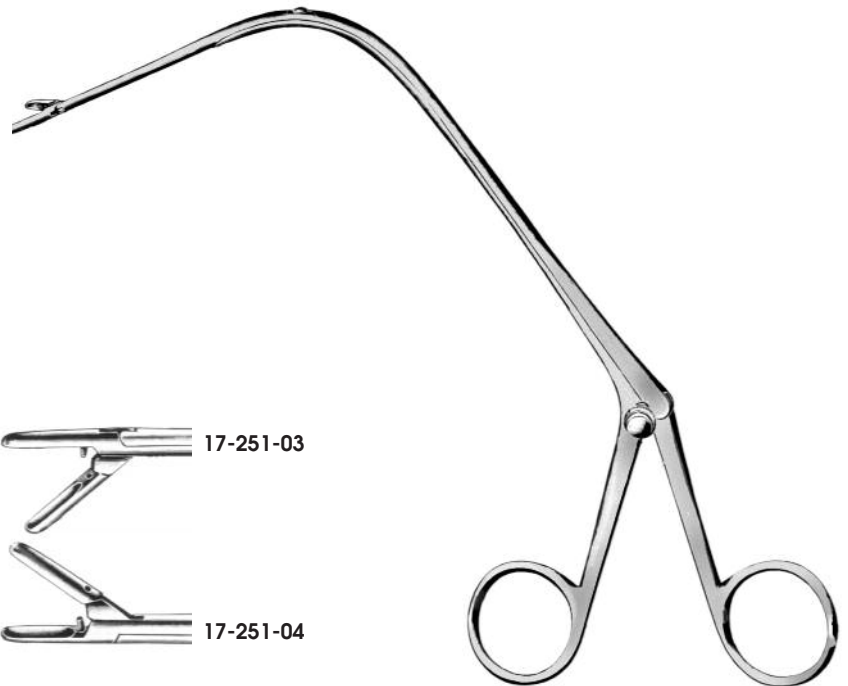

Jurasz, 22,0 cm

Brünings
Ansatzrohr starr, gerade
 Straight Tubes with Stylet, stiff
 20,0 cm **17-262-20**
 30,0 cm **17-262-30**
 40,0 cm **17-262-40**



Brünings
Ansatzrohr starr, gebogen
 Curved Tubes with Stylet, stiff
 20,0 cm **17-267-20**

Ansatzrohr biegsam, gebogen
 Curved Tubes with Stylet, malleable
 20,0 cm **17-268-20**

Fränkel
17-270-01



Kahler
17-270-02



Fränkel
17-270-04



Huber Universal-Griff
17-262-00

Scheinmann
17-270-06



Scheinmann
17-270-15



Brünings
17-270-08
17-270-09



Schumacher
17-270-16



Lange
17-270-11



Cordes
17-270-17
17-270-18



Krause
17-270-13
17-270-14



Rosenberg
17-270-19





Trousseau
12,0 cm 17-315-12



Laborde
13,5 cm 17-317-13



Iterson, 17,0 cm



17-321-01



17-321-02



Bose, 16,5 cm



17-323-01



17-323-02



Rose
13,5 cm 17-325-13



Luer
11,0cm 17-327-11



Jackson
15,0 cm 17-329-15

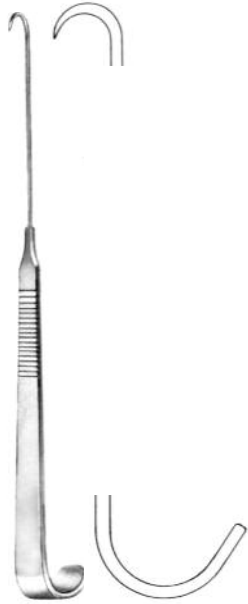

News
 15,0 cm 17-331-15



Jackson
 17,0 cm 17-335-17

Lukens
 17,0 cm 17-333-17

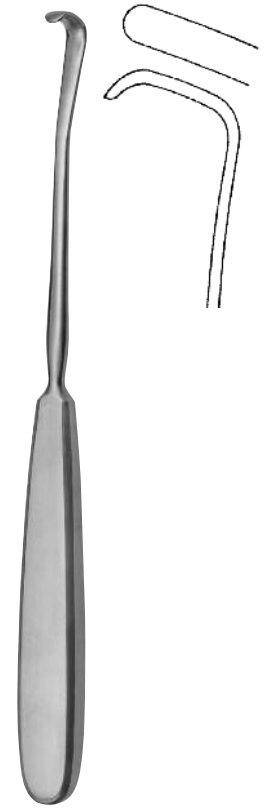

Schoenborn
 20,5 cm 17-337-21



Kocher



15,0 cm
 17-339-01



15,0 cm
 17-339-02



17,0 cm
 17-339-03







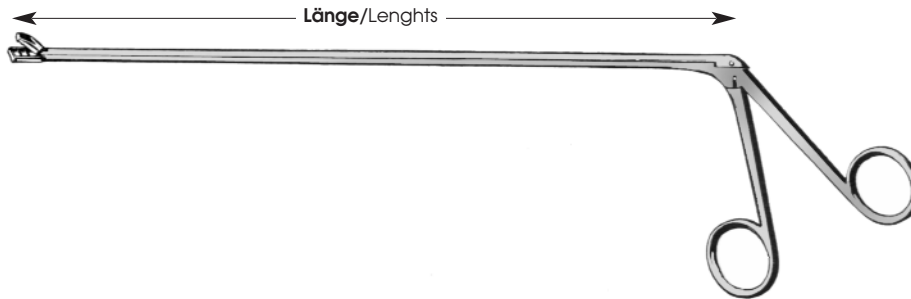

Lahey
 15,0 cm 17-340-15
 20,0 cm 17-340-20



Mastin
 15,0 cm 17-341-17



	Schaft 30 cm Shaft 30 cm	Schaft 40 cm Shaft 40 cm	Schaft 50 cm Shaft 50 cm	Schaft 60 cm Shaft 60 cm	
	17-410-30	17-410-40	17-410-50	17-410-60	Probeextensions-Zange Biopsy Punch
	17-411-30	17-411-40	17-411-50	17-411-60	Probeextensions-Zange Biopsy Punch
	17-412-30	17-412-40	17-412-50	17-412-60	Alligatorzange Alligator Forceps
	17-413-30	17-413-40	17-413-50	17-413-60	Löffelzange Cup-shaped Forceps
	17-414-30	17-414-40	17-414-50	17-414-60	Probeextensions-Zange Biopsy Punch
	17-415-30	17-415-40	17-415-50	17-415-60	Fasszange Grasping Forceps
	17-416-30	17-416-40	17-416-50	17-416-60	Löffelzange Cup-shaped Forceps



17-504-01



17-504-02



17-504-03



Voltolini



Tieck-Halle



Fig. 1

17-506-01



Fig. 2

17-506-02

Steckschluss
 aseptic joint
Schraubschluss
 screw joint

17-507-01

17-507-02

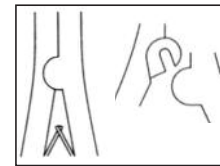

Steckschluss
 aseptic joint

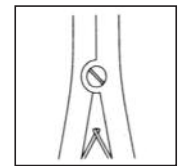

Schraubschluss
 screw joint



Hartmann-Halle



Fig. 1

17-508-01

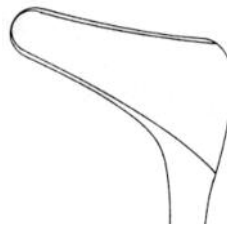

Fig. 2

17-508-02

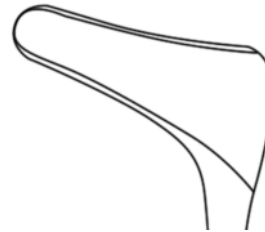

Fig. 3

17-508-03

Steckschluß
 aseptic joint
Schraubschluß
 screw joint

17-509-01

17-509-02

17-509-03



Fig. 1

17-515-01

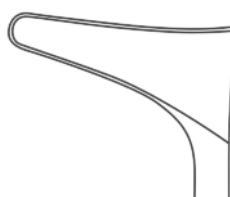

Fig. 2

17-515-02

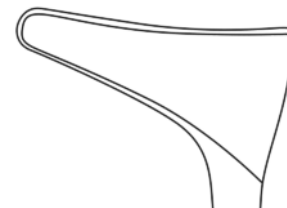
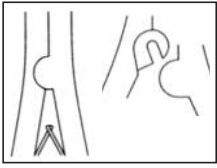

Fig. 3

17-515-03



Modell Wien



Steckschluss
aseptic joint

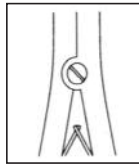

Schraubschluss
screw joint

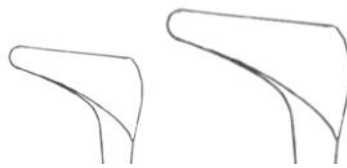

17-519-14

17-519-15



Beckmann

Steckschluss/screw joint
Schraubschluss/aseptic joint

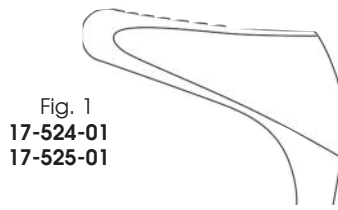

Fig. 1
17-524-01
17-525-01

Steckschluss/screw joint
Schraubschluss/aseptic joint

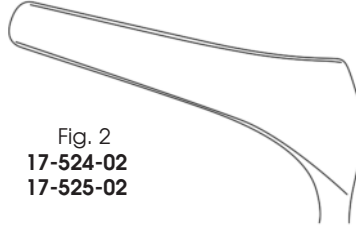

Fig. 2
17-524-02
17-525-02

Steckschluss/screw joint
Schraubschluss/aseptic joint

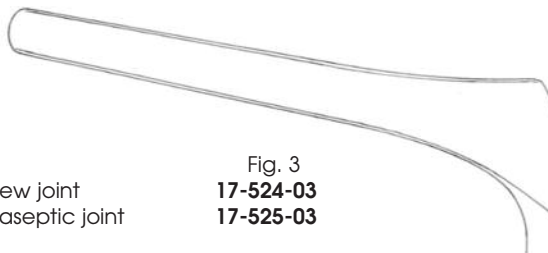

Fig. 3
17-524-03
17-525-03

Steckschluss/screw joint
Schraubschluss/aseptic joint

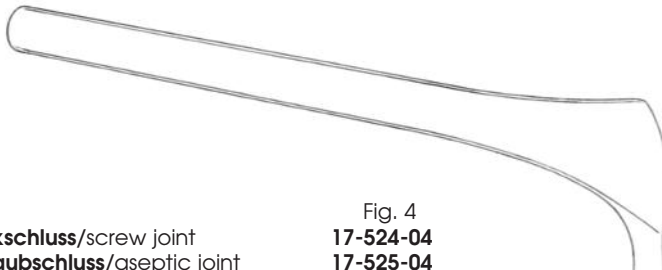

Fig. 4
17-524-04
17-525-04



Killian



Cottle



Fig. 1
17-528-01
17-530-01 schwarz/black

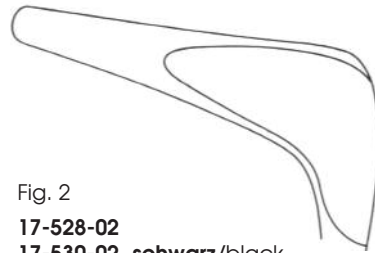

Fig. 2
17-528-02
17-530-02 schwarz/black

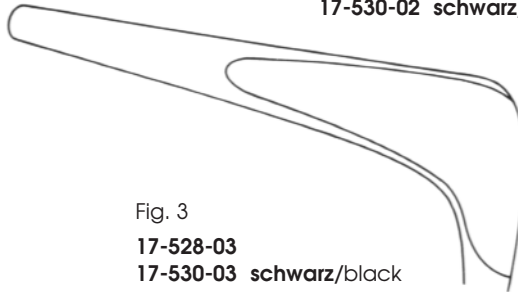

Fig. 3
17-528-03
17-530-03 schwarz/black

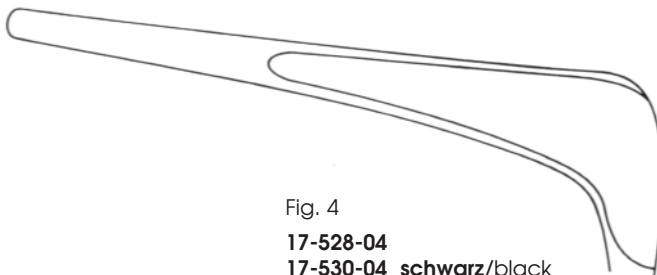

Fig. 4
17-528-04
17-530-04 schwarz/black

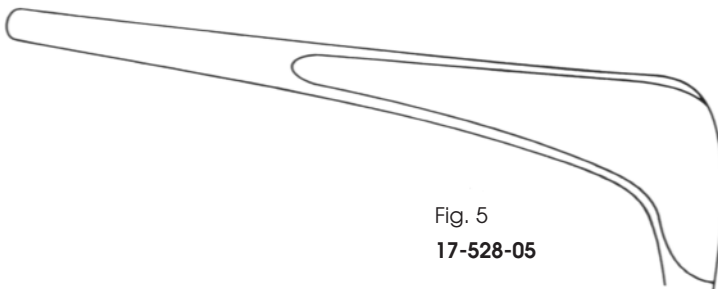

Fig. 5
17-528-05



Cottle
schwarz
 black finish



Lubet-Barbon
20,0 cm 17-603-20

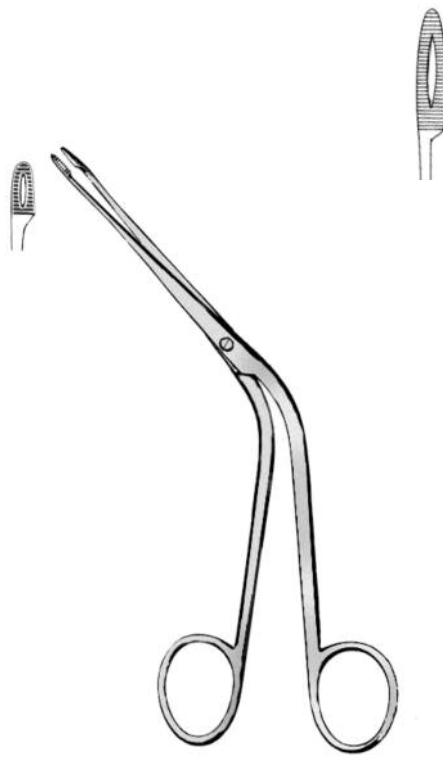

Hartmann
16,0 cm 17-607-16



Hartmann
20,0 cm 17-607-20



Heymann
18,0 cm 17-609-18



Littauer
18,0 cm 17-611-18



Krause
 26,0 cm 17-621-26



17-627-99
 0,3 mm Ø



Krause-Voss
 26,0 cm 17-623-26



Joseph, 14,5 cm



17-640-14

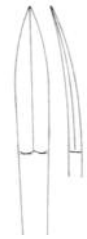

17-641-14



Brünings
 16,0 cm 17-642-16



Fomon
 16,0 cm 17-645-16



Freer
 15,5 cm 17-646-15



Freer
 18,5 cm 17-646-18

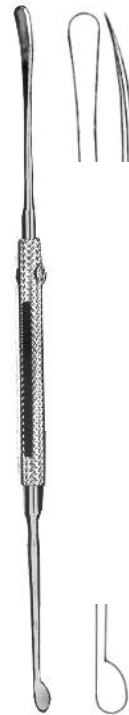

Sichelmesser
 Sickle Knife



19,0 cm 17-648-01



19,0 cm 17-648-02



19,0 cm 17-648-03



Converse
16,0 cm 17-649-16



Joseph
15,0 cm 17-650-15



Cottle
15,0 cm 17-652-15



Cottle
15,0 cm 17-654-15

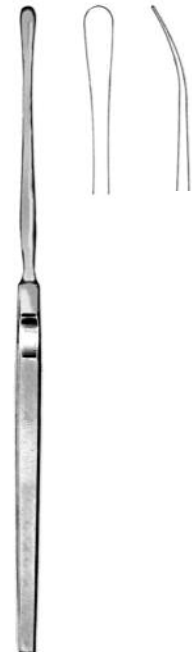

Halle
18,0 cm 17-655-18

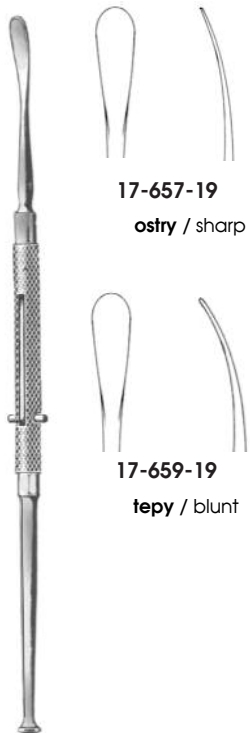

Freer, 19,0 cm

17-657-19
ostry / sharp

17-659-19
tepy / blunt



Freer, 19,0 cm

17-668-19



Freer, 19,0 cm

17-669-01



17-669-02



Freer
18,0 cm 17-663-18
20,0 cm 17-663-20

ostry / sharp

tepy / blunt



Freer
20,0 cm 17-665-20

ostry / sharp

tepy / blunt

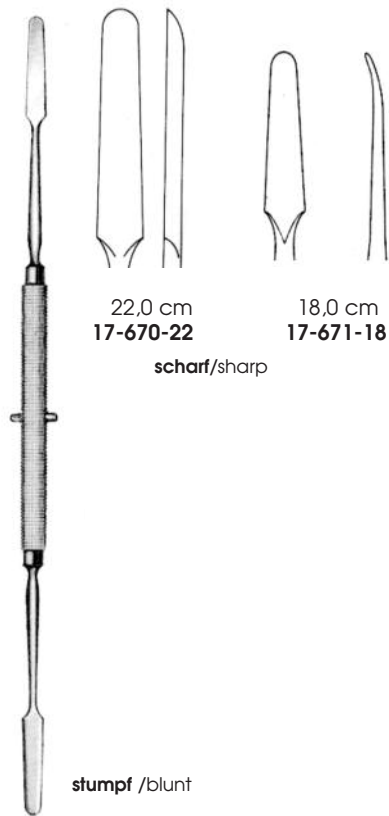

Killian

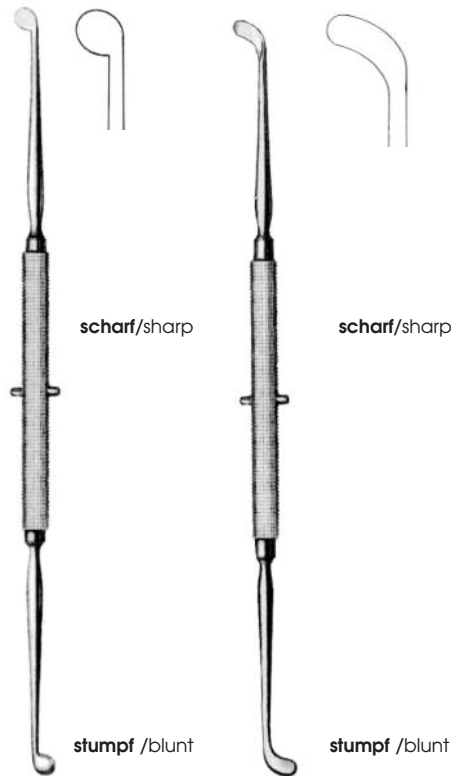

Pierce

21,0 cm 17-672-21

Pennington

21,0 cm 17-673-21

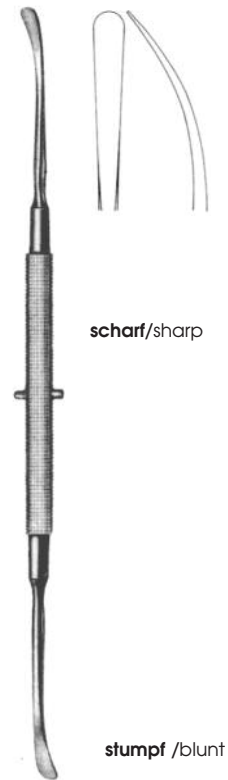

Roger

19,0 cm 17-675-19

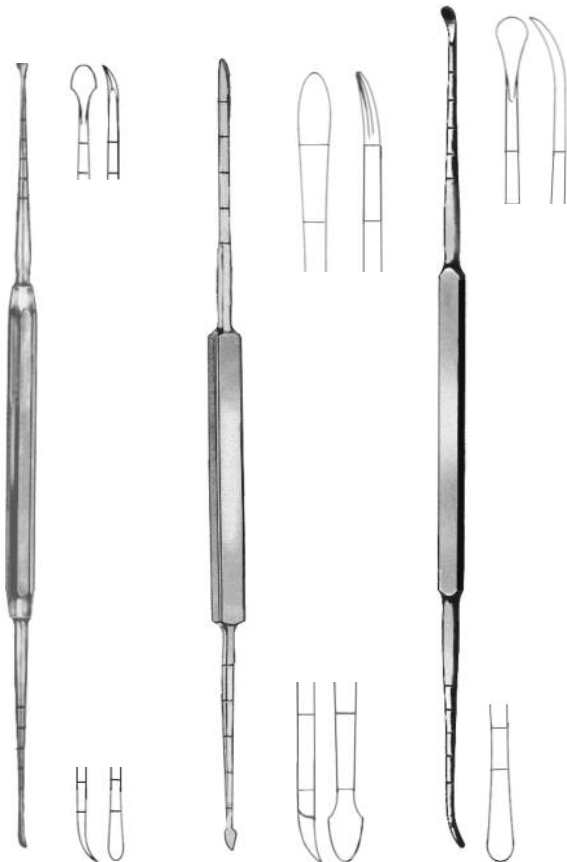

Massing
21,0 cm 17-679-21

Cottle
21,0 cm 17-681-21

Cottle
22,0 cm 17-681-22

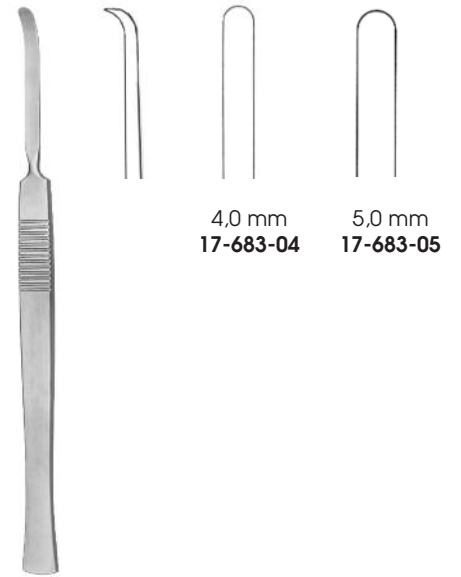

McKenty, 15,0 cm

4,0 mm
17-683-04

5,0 mm
17-683-05



Joseph
16,0 cm 17-685-16

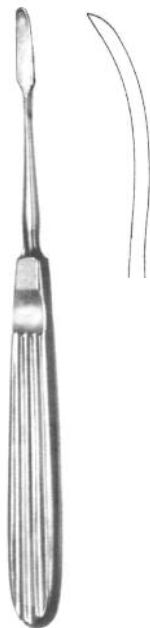

Joseph
16,0 cm 17-687-16



Joseph
22,0 cm 17-688-22



Sewall
20,0 cm 17-689-20



McKenty, 21,0 cm
17-691-21

Cottle, 22,0 cm
17-693-22



Freer, 16,0 cm
17-701-16

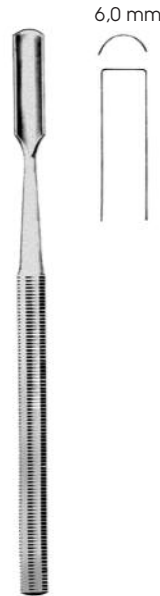

Freer
 15,0 cm **17-702-15**

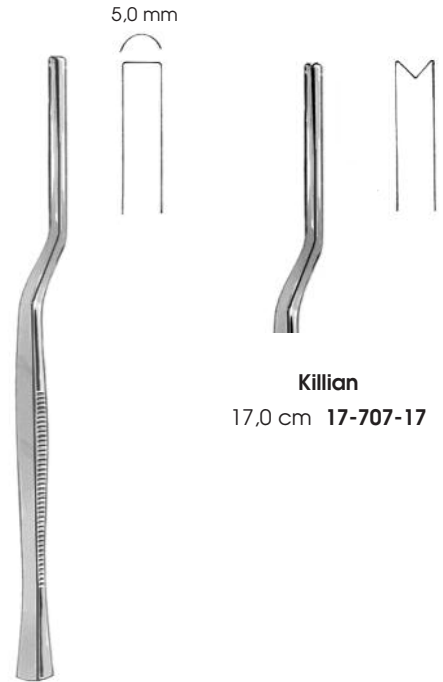

Killian
 17,0 cm **17-707-17**

Freer
 16,0 cm **17-700-16**

Killian
 17,0 cm **17-705-17**



Ballenger
 17-710-03 - 17-710-05

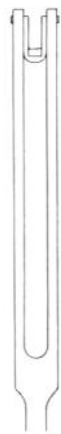

3,0 mm
17-710-03
17-711-03

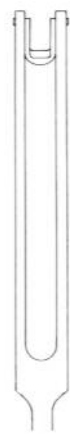

4,0 mm
17-710-04
17-711-04



5,0 mm
17-710-05
17-711-05



Ballenger
 17-711-03 - 17-711-05

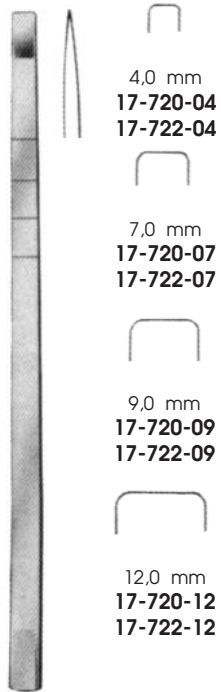

4,0 mm
17-720-04
17-722-04

7,0 mm
17-720-07
17-722-07

9,0 mm
17-720-09
17-722-09

12,0 mm
17-720-12
17-722-12

Cottle, 18,0 cm
17-720-04 - 17-720-12

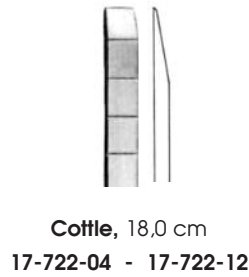

Cottle, 18,0 cm
17-722-04 - 17-722-12

Cottle, 18,0 cm
17-721-06

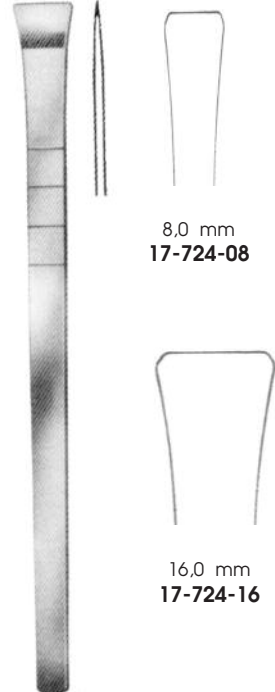

8,0 mm
17-724-08

16,0 mm
17-724-16

Cottle, 18,0 cm
17-724-08 - 17-724-16

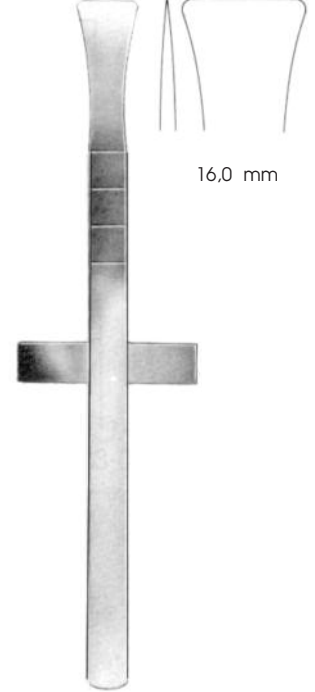

16,0 mm

Cottle, 18,0 cm
17-726-16

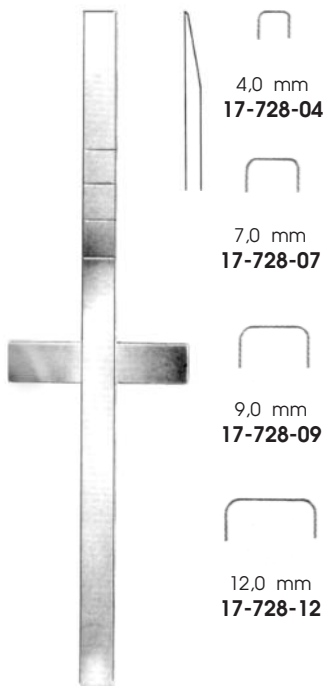

4,0 mm
17-728-04

7,0 mm
17-728-07

9,0 mm
17-728-09

12,0 mm
17-728-12

Cottle, 18,0 cm
17-728-04 - 17-728-12

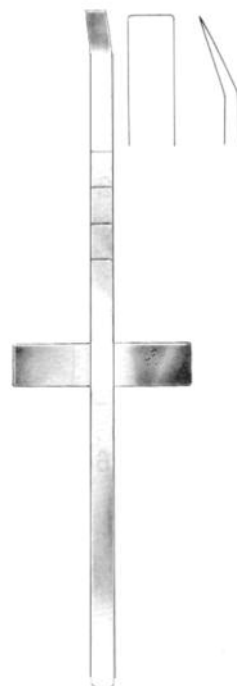

Cottle, 18,0 cm
17-729-06

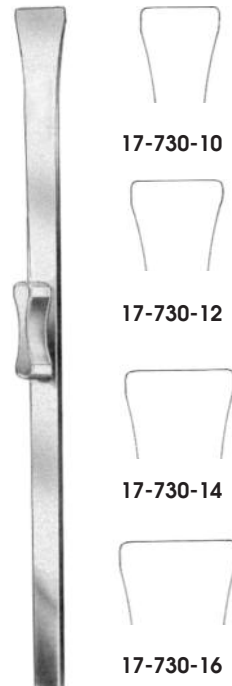

17-730-10

17-730-12

17-730-14

17-730-16

Rubin, 18,0 cm
17-730-10 - 17-730-16



3,0 mm
17-732-03

4,0 mm
17-732-04

2,0 mm
17-733-02

3,0 mm
17-733-03

4,0 mm
17-733-04

7,0 mm
17-733-07

9,0 mm
17-733-09

12,0 mm
17-733-12

Walter, 19,0 cm

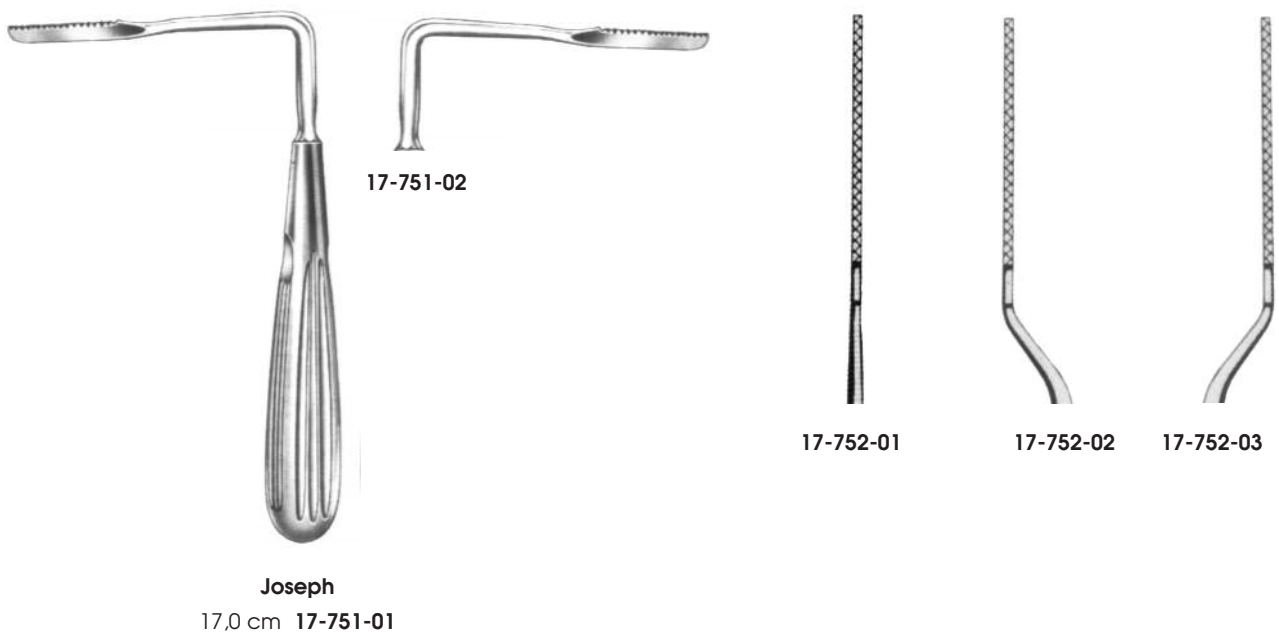
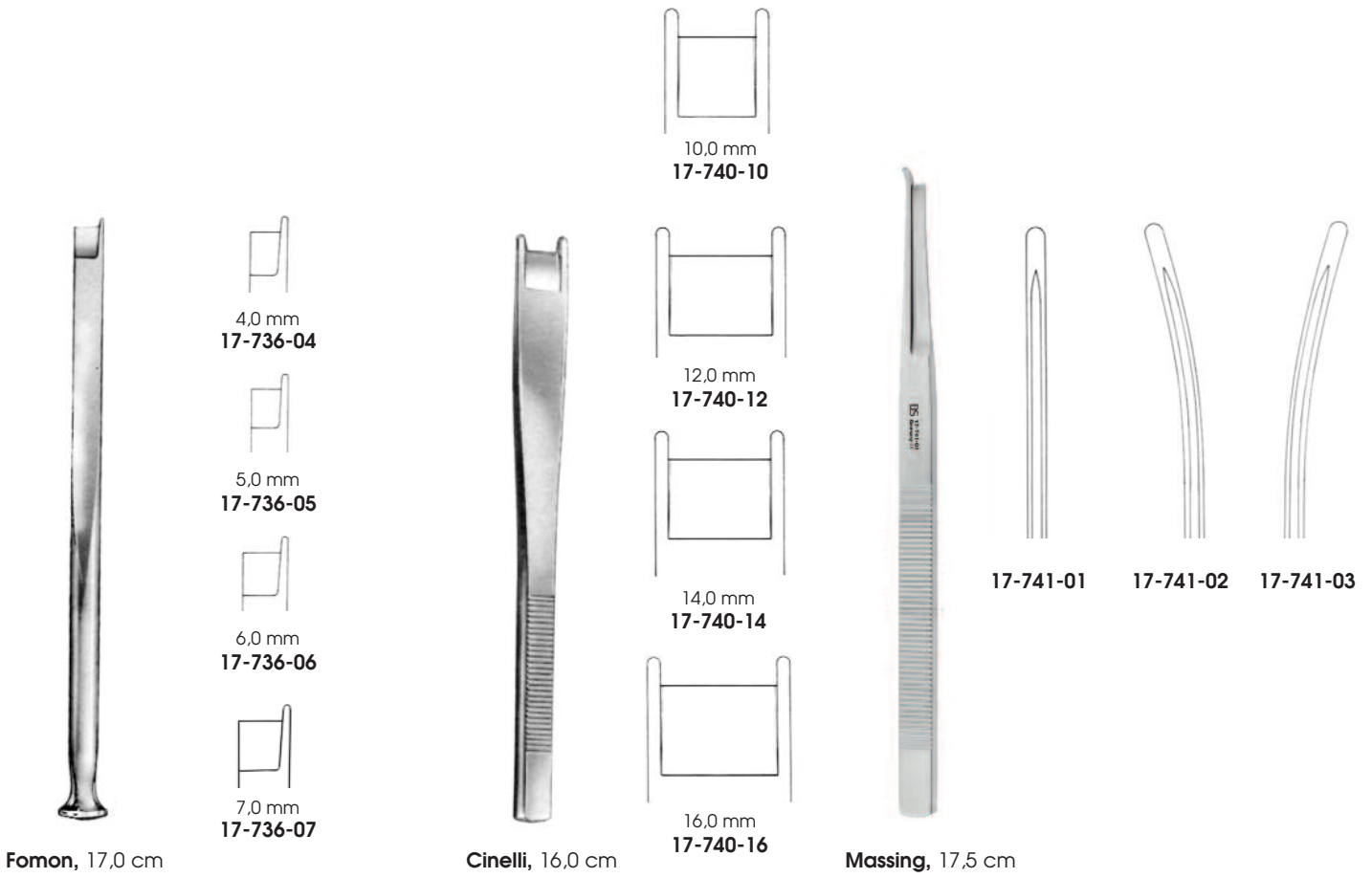



Cottle
Knorpelquetschinstrument
Bone crusher
17-756-00



Columella
10,0 cm 17-760-10



Cottle
14,0 cm 17-761-14



Graefe
11,0 cm 17-762-11



Aufricht
16,0 cm 17-767-16



Walter
13,5 cm 17-769-13



Kilner, 10,0 cm

17-770-10
scharf
sharp

17-770-11
stumpf
blunt



Converse
12,0 cm 17-771-12



Cottle, 15,0 cm



17-772-01



17-772-02



17-772-03

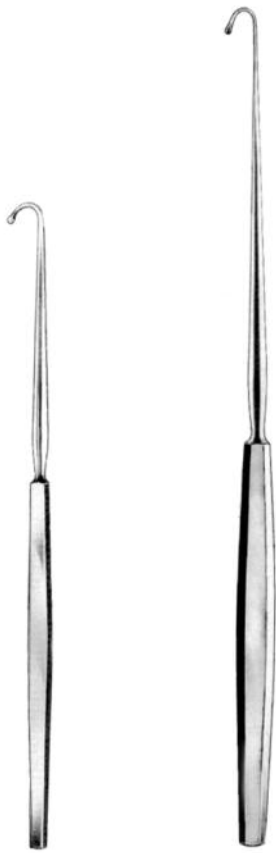

Fomon 17,0 cm **17-776-17** **Lange** 22,0 cm **17-777-22**

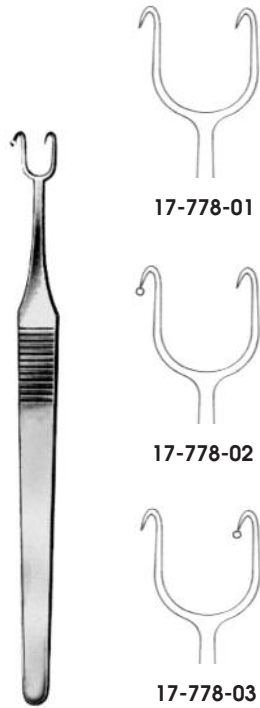

Cottle, 15,0 cm

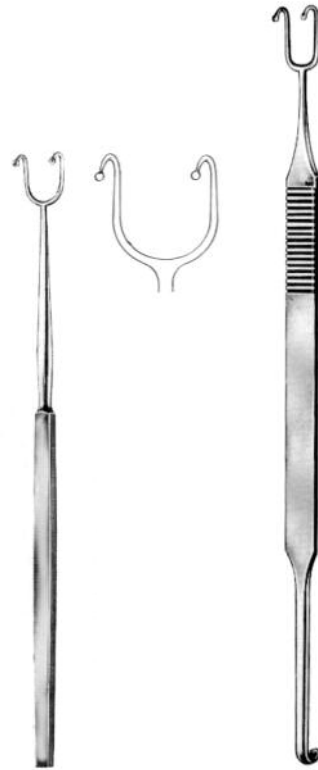

Fomon 16,0 cm **17-779-16**

Cottle 20,0 cm **17-780-20**



Neifert 16,0 cm **17-782-16**

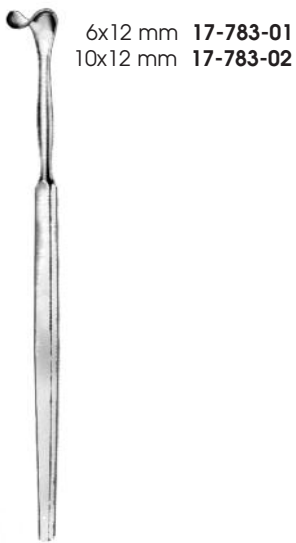

Massing, 14,0 cm



Cottle 15,0 cm **17-785-15**



Cookley, 17,0 cm

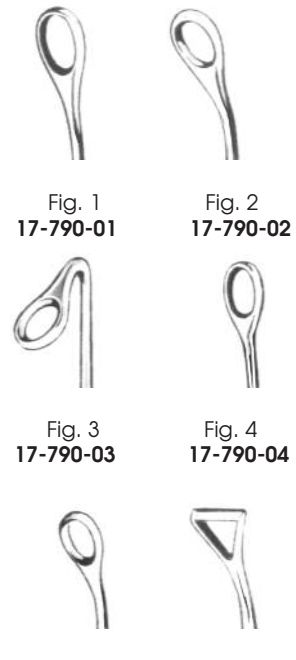

Fig. 1
17-790-01

Fig. 2
17-790-02

Fig. 3
17-790-03

Fig. 4
17-790-04

Fig. 5
17-790-05

Fig. 6
17-790-06



17-801-01

17-803-01



17-803-02

Craig, 17,0 cm

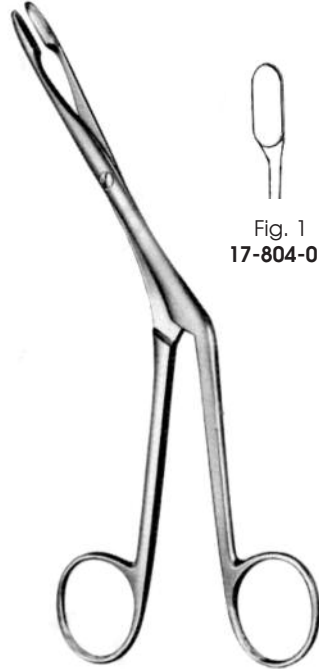

Fig. 1
17-804-01

Fig. 2
17-804-02

Fig. 3
17-804-03

Heymann
18,0 cm 17-804-01

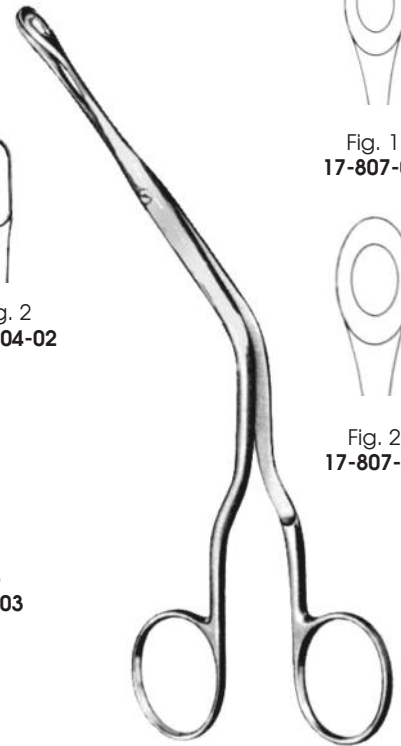

Fig. 1
17-807-01

Fig. 2
17-807-02

Luc, 20,0 cm



Fig. 1
17-811-01

Fig. 2
17-811-02

Luc, 20,0 cm



Fig. 1
17-813-01

Fig. 2
17-813-02

Fig. 3
17-813-03

Fig. 4
17-813-04

Brünings, 19,0 cm



Ash
 22,0 cm 17-825-22



Cottle-Walsham, 22,0 cm



Fig. 1
 17-826-01



Fig. 2
 17-826-02



Fig. 3
 17-826-03



Kressner, 22,0 cm



3,0 mm
 17-829-03



4,0 mm
 17-829-04



Middleton-Jansen, 19,0 cm



17-830-01



17-830-03

durchschneidend
through-cutting

gezahnt
serrated



Caplan
20,0 cm 17-841-20

gezahnt
serrated



Killian
21,0 cm 17-843-21











Rubin
21,0 cm 17-845-21



kurze Maulöffnung
 short jaw opening

**Blakesley
 extra fein**
 very delicate

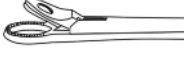
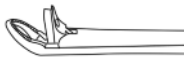
Blakesley Nasenzangen Blakesley Nasal Forceps	 3,0 mm	 3,5 mm	 4,2 mm	
 gerade straight	17-870-30	17-870-35	17-870-42	
 45°	17-871-30	17-871-35	17-871-42	
Blakesley Durchschneidezangen Blakesley Throughcut Forceps Schnittbreite bit	 2,2 mm	 2,5 mm	 3,0 mm	 3,7 mm
 gerade straight	17-880-22	17-880-25	17-880-30	17-880-37
 45°	17-880-22	17-880-25	17-880-30	17-880-37