

01

Scheren

Sissors

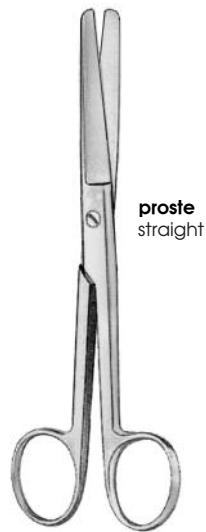

proste
straight

Standard,
Fig. 1

10,0 cm **01-000-10**
11,0 cm **01-000-11**
13,0 cm **01-000-13**
14,0 cm **01-000-14**
15,0 cm **01-000-15**
16,0 cm **01-000-16**
17,0 cm **01-000-17**
18,0 cm **01-000-18**
20,0 cm **01-000-20**



zakrzywione
curved

Standard,
Fig. 1

10,0 cm **01-001-10**
11,0 cm **01-001-11**
13,0 cm **01-001-13**
14,0 cm **01-001-14**
15,0 cm **01-001-15**
16,0 cm **01-001-16**
17,0 cm **01-001-17**
18,0 cm **01-001-18**
20,0 cm **01-001-20**



proste
straight

Standard
Fig. 2

10,0 cm **01-002-10**
11,0 cm **01-002-11**
13,0 cm **01-002-13**
14,0 cm **01-002-14**
15,0 cm **01-002-15**
16,0 cm **01-002-16**
17,0 cm **01-002-17**
18,0 cm **01-002-18**
20,0 cm **01-002-20**



zakrzywione
curved

Standard
Fig. 2

10,0 cm **01-003-10**
11,0 cm **01-003-11**
13,0 cm **01-003-13**
14,0 cm **01-003-14**
15,0 cm **01-003-15**
16,0 cm **01-003-16**
17,0 cm **01-003-17**
18,0 cm **01-003-18**
20,0 cm **01-003-20**



proste
straight

Standard
Fig. 3

10,0 cm **01-004-10**
11,0 cm **01-004-11**
13,0 cm **01-004-13**
14,0 cm **01-004-14**
15,0 cm **01-004-15**
16,0 cm **01-004-16**
17,0 cm **01-004-17**
18,0 cm **01-004-18**
20,0 cm **01-004-20**



zakrzywione
curved

Standard
Fig. 3

10,0 cm **01-005-10**
11,0 cm **01-005-11**
13,0 cm **01-005-13**
14,0 cm **01-005-14**
15,0 cm **01-005-15**
16,0 cm **01-005-16**
17,0 cm **01-005-17**
18,0 cm **01-005-18**
20,0 cm **01-005-20**



gerade
 straight

Chir. Schere, grazil
 Fig. 1
 13,0 cm **01-010-13**
 14,0 cm **01-010-14**



gebogen
 curved

Chir. Schere, grazil
 Fig. 1
 13,0 cm **01-011-13**
 14,0 cm **01-011-14**



gerade
 straight

Chir. Schere, grazil
 Fig. 2
 13,0 cm **01-012-13**
 14,0 cm **01-012-14**



gebogen
 curved

Chir. Schere, grazil
 Fig. 2
 13,0 cm **01-013-13**
 14,0 cm **01-013-14**



gerade
 straight

Chir. Schere, grazil
 Fig. 3
 13,0 cm **01-014-13**
 14,0 cm **01-014-14**



gebogen
 curved

Chir. Schere, grazil
 Fig. 3
 13,0 cm **01-015-13**
 14,0 cm **01-015-14**



gerade, 1 Blatt gezahnt
straight, 1 blade serrated

Wundrandschere
Scissors for wound edges
13,0 cm **01-020-13**



gebogen, 1 Blatt gezahnt
curved, 1 blade serrated

Wundrandschere
Scissors for wound edges
13,0 cm **01-021-13**

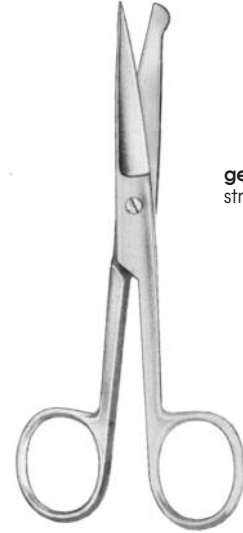

gerade
straight

Chir. Schere
13,0 cm **01-100-13**
14,0 cm **01-100-14**



gerade
straight

Chir. Schere
15,0 cm **01-102-15**



gerade
straight

Deaver
14,0 cm **01-104-14**



gebogen
curved

Deaver
14,0 cm **01-105-14**

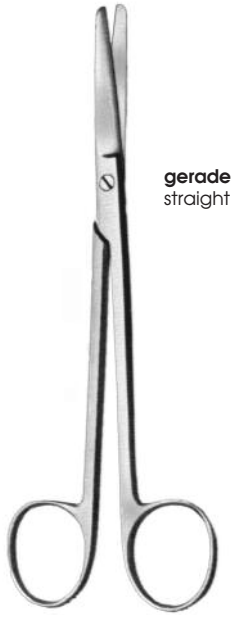

gerade
straight

Mixer
 15,0 cm 01-106-15



gebogen
curved

Mixer
 15,0 cm 01-107-15



abgewinkelt
angled

Richter
 14,0 cm 01-109-14



abgewinkelt
angled

Fergusson
 18,0 cm 01-111-18

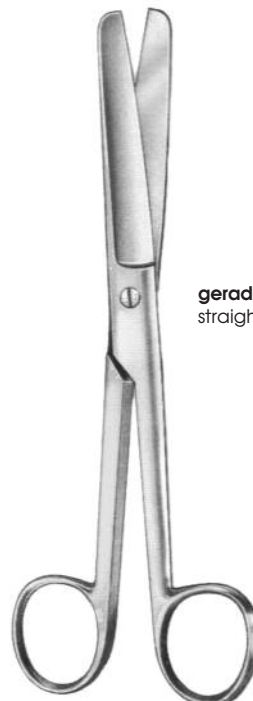

gerade
straight

Doyen
 16,0 cm 01-114-16



gebogen
curved

Doyen
 16,0 cm 01-115-16



gerade
straight

Sims
Fig. 1

20,0 cm **01-120-20**
23,0 cm **01-120-23**
25,0 cm **01-120-25**



gebogen
curved

Sims
Fig. 1

20,0 cm **01-121-20**
23,0 cm **01-121-23**
25,0 cm **01-121-25**



gerade
straight

Sims
Fig. 2

20,0 cm **01-122-20**
23,0 cm **01-122-23**
25,0 cm **01-122-25**



gebogen
curved

Sims
Fig. 2

20,0 cm **01-123-20**
23,0 cm **01-123-23**
25,0 cm **01-123-25**



gerade
straight

Sims
Fig. 3

20,0 cm **01-124-20**
23,0 cm **01-124-23**
25,0 cm **01-124-25**



gebogen
curved

Sims
Fig. 3

20,0 cm **01-125-20**
23,0 cm **01-125-23**
25,0 cm **01-125-25**

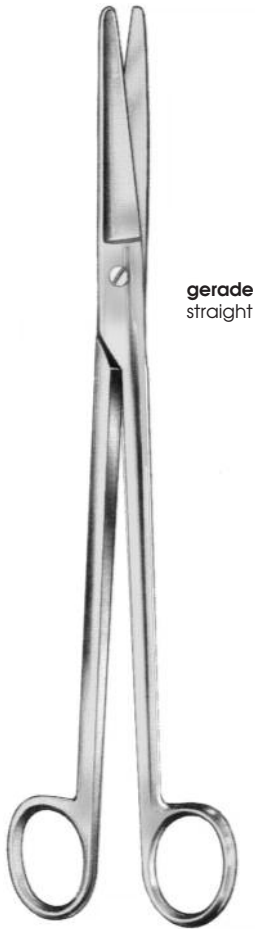

gerade
straight

Sims-Siebold
25,0 cm **01-126-25**



S-förmig
s-shaped

Sims-Siebold
24,0 cm **01-127-24**

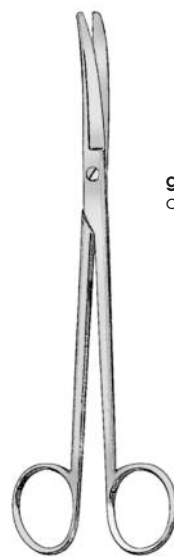

gebogen
curved

Wertheim
14,0 cm **01-131-14**
20,0 cm **01-131-20**
22,0 cm **01-131-22**



gerade
straight

Dubois

27,0 cm **01-132-27**



gebogen
curved

Dubois

27,0 cm **01-133-27**



gebogen
curved

Crafoord

30,0 cm **01-137-30**



Braun-Stadler

14,0 cm **01-139-14**
22,0 cm **01-139-22**



Waldmann

18,0 cm **01-141-18**

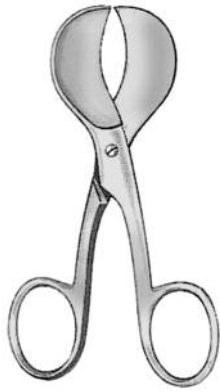

Modell USA
10,0 cm 01-144-10

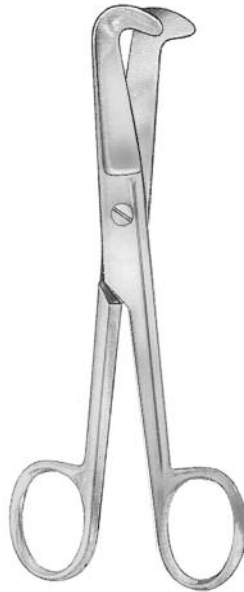

Schuhmacher
16,0 cm 01-145-16

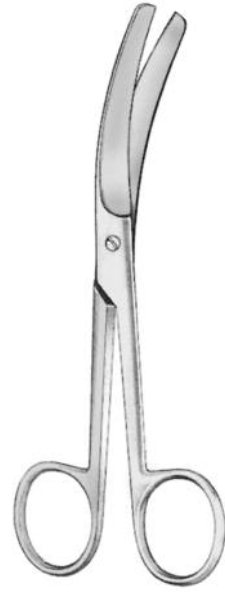

Busch
13,0 cm 01-147-13
16,0 cm 01-147-16

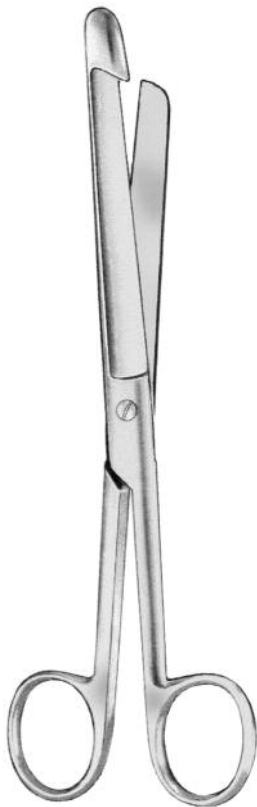

Darmschere
Bowel Scissors
21,0 cm 01-150-21

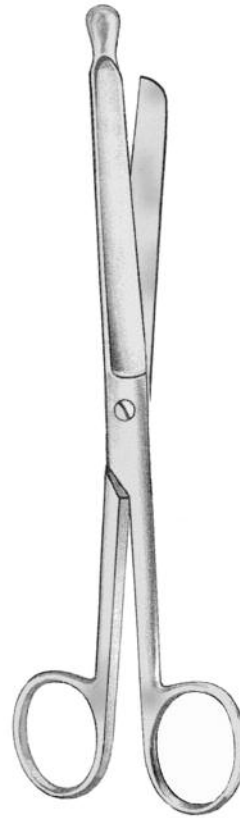

Darmschere
Bowel Scissors
21,0 cm 01-151-21



proste
straight

Mayo

14,0 cm **01-160-14**
15,0 cm **01-160-15**
17,0 cm **01-160-17**
19,0 cm **01-160-19**
23,0 cm **01-160-23**



zakrzywione
curved

Mayo

14,0 cm **01-161-14**
15,0 cm **01-161-15**
17,0 cm **01-161-17**
19,0 cm **01-161-19**
23,0 cm **01-161-23**



proste
straight

Mayo-Harrington

22,0 cm **01-166-22**



zakrzywione
curved

Mayo-Harrington

22,0 cm **01-167-22**

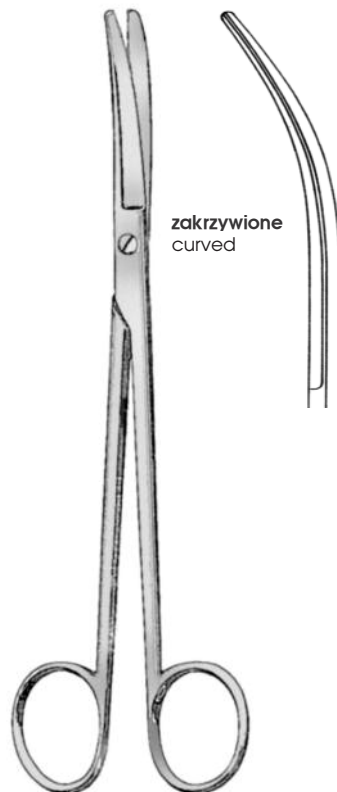

zakrzywione
curved

Wertheim-Parametrium

22,0 cm **01-169-22**

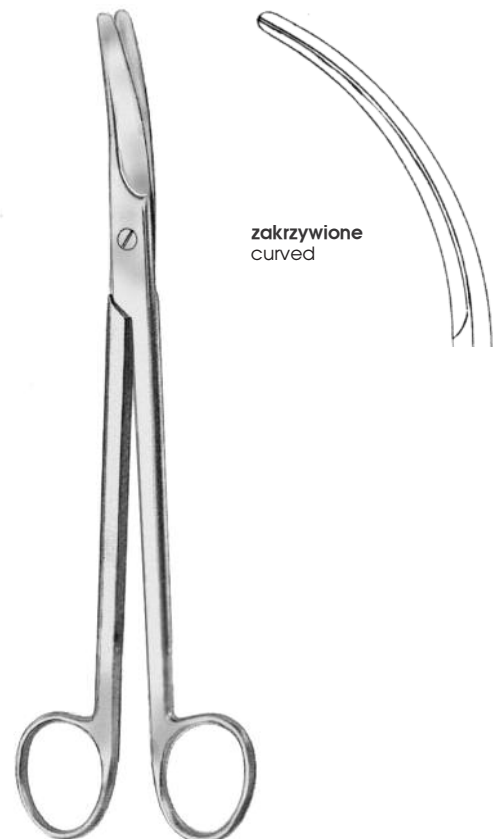

zakrzywione
curved

Parametrium

23,0 cm **01-169-23**

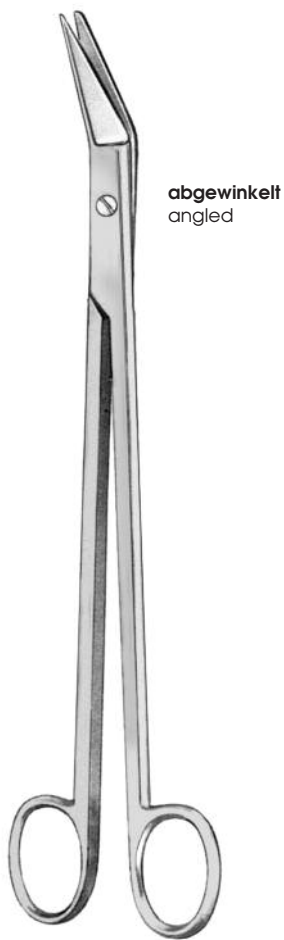

abgewinkelt
 angled

Resano Kapselschere
Cortilage Scissors

24,5 cm **01-175-24**



gerade
 straight

Mayo-Stille

- 15,0 cm **01-170-15**
- 17,0 cm **01-170-17**
- 19,0 cm **01-170-19**
- 21,0 cm **01-170-21**
- 23,0 cm **01-170-23**



gebogen
 curved

Mayo-Stille

- 15,0 cm **01-171-15**
- 17,0 cm **01-171-17**
- 19,0 cm **01-171-19**
- 21,0 cm **01-171-21**
- 23,0 cm **01-171-23**



gerade
 straight

Mayo-Noble

17,0 cm **01-176-17**



gebogen
 curved

Mayo-Noble

17,0 cm **01-177-17**



proste
straight

Metzenbaum
Fig.1

- 14,0 cm **01-200-14**
- 18,0 cm **01-200-18**
- 20,0 cm **01-200-20**
- 23,0 cm **01-200-23**
- 25,0 cm **01-200-25**
- 28,0 cm **01-200-28**
- 30,0 cm **01-200-30**



zakrzywione
curved

Metzenbaum
Fig.1

- 14,0 cm **01-201-14**
- 18,0 cm **01-201-18**
- 20,0 cm **01-201-20**
- 23,0 cm **01-201-23**
- 25,0 cm **01-201-25**
- 28,0 cm **01-201-28**
- 30,0 cm **01-201-30**



proste
straight

Metzenbaum
Fig.2

- 14,0 cm **01-202-14**
- 18,0 cm **01-202-18**
- 20,0 cm **01-202-20**
- 23,0 cm **01-202-23**
- 25,0 cm **01-202-25**
- 28,0 cm **01-202-28**
- 30,0 cm **01-202-30**



zakrzywione
curved

Metzenbaum
Fig.2

- 14,0 cm **01-203-14**
- 18,0 cm **01-203-18**
- 20,0 cm **01-203-20**
- 23,0 cm **01-203-23**
- 25,0 cm **01-203-25**
- 28,0 cm **01-203-28**
- 30,0 cm **01-203-30**



proste
straight

Metzenbaum
Fig.3

- 14,0 cm **01-204-14**
- 18,0 cm **01-204-18**
- 20,0 cm **01-204-20**
- 23,0 cm **01-204-23**
- 25,0 cm **01-204-25**
- 28,0 cm **01-204-28**
- 30,0 cm **01-204-30**



zakrzywione
curved

Metzenbaum
Fig.3

- 14,0 cm **01-205-14**
- 18,0 cm **01-205-18**
- 20,0 cm **01-205-20**
- 23,0 cm **01-205-23**
- 25,0 cm **01-205-25**
- 28,0 cm **01-205-28**
- 30,0 cm **01-205-30**



gerade
straight

Metzenbaum-Fino
Fig.1

14,0 cm **01-210-14**
 18,0 cm **01-210-18**
 20,0 cm **01-210-20**
 23,0 cm **01-210-23**



gebogen
curved

Metzenbaum-Fino
Fig.1

14,0 cm **01-211-14**
 18,0 cm **01-211-18**
 20,0 cm **01-211-20**
 23,0 cm **01-211-23**



gerade
straight

Metzenbaum-Fino
Fig.3

14,0 cm **01-214-14**
 18,0 cm **01-214-18**
 20,0 cm **01-214-20**
 23,0 cm **01-214-23**



gebogen
curved

Metzenbaum-Fino
Fig.3

14,0 cm **01-215-14**
 18,0 cm **01-215-18**
 20,0 cm **01-215-20**
 23,0 cm **01-215-23**



S-förmig
S-shaped

Metzenbaum-Fino
Fig.1

14,0 cm **01-221-14**
 18,0 cm **01-221-18**
 20,0 cm **01-221-20**
 23,0 cm **01-221-23**



gerade
straight

Metzenbaum
Fig.1

15,0 cm **01-226-15**



gebogen
curved

Metzenbaum
Fig.1
15,0 cm **01-227-15**



gerade
straight

Metzenbaum-Baby
11,0 cm 01-228-11

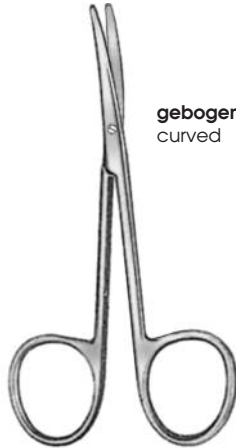

gebogen
curved

Metzenbaum-Baby
11,0 cm 01-229-11



gerade
straight

Lexer
16,0 cm 01-230-16



gebogen
curved

Lexer
16,0 cm 01-231-16

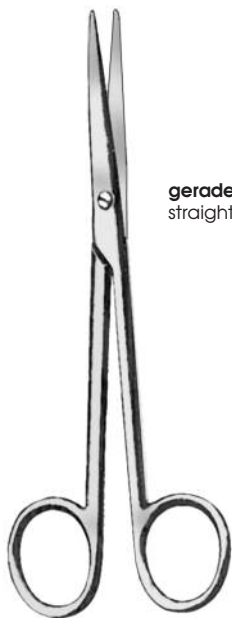

gerade
straight

Lexer-Fino
16,0 cm 01-232-16

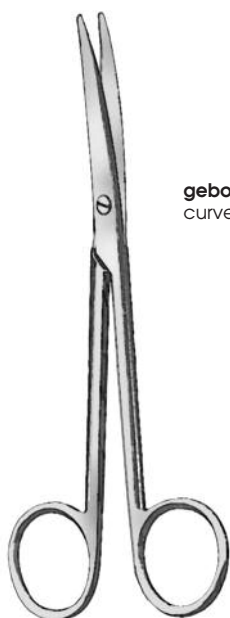

gebogen
curved

Lexer-Fino
16,0 cm 01-233-16



gerade
straight

Lexer-Baby
10,0 cm 01-234-10



gebogen
curved

Lexer-Baby
10,0 cm 01-235-10



gerade
 straight

Strabismus

11,0 cm 01-236-11



gebogen
 curved

Strabismus

11,0 cm 01-237-11



gebogen
 curved

Fomon

14,0 cm 01-239-14

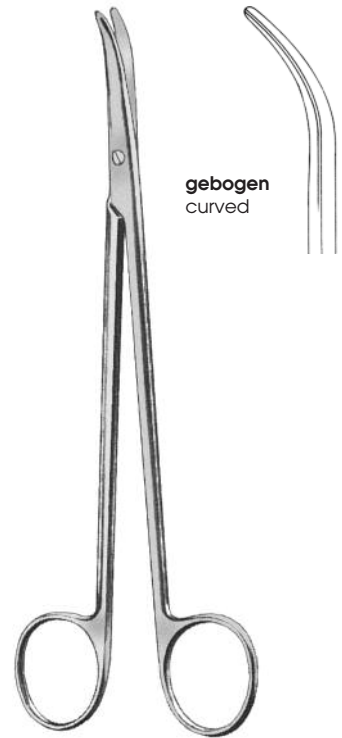

gebogen
 curved

Thorek

19,0 cm 01-241-19



gerade, gezahnt
 straight, serrated

Gorney

12,5 cm 01-242-12
 19,5 cm 01-242-19

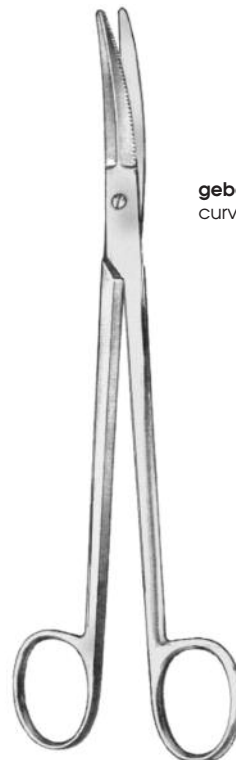

gebogen, gezahnt
 curved, serrated

Gorney

19,5 cm 01-243-19



gebogen
curved

Kilner (Ragnell)
12,0 cm **01-245-12**
15,0 cm **01-245-15**

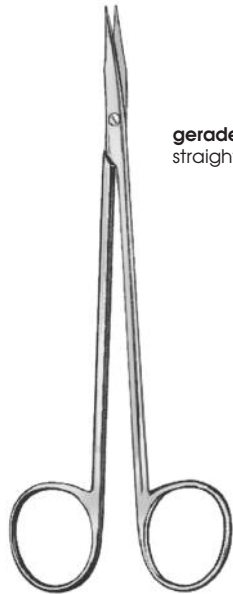

gerade
straight

Reynolds
15,0 cm **01-248-15**
18,0 cm **01-248-18**



gebogen
curved

Reynolds
15,0 cm **01-249-15**
18,0 cm **01-249-18**

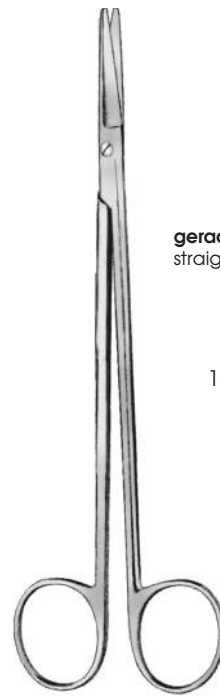

gerade
straight

Tönnis
18,0 cm **01-250-18**



gebogen
curved

Tönnis
18,0 cm **01-251-18**



gebogen
curved

Tönnis-Adson
17,5 cm **01-253-17**



gerade, gezahnt
straight, serrated

Beuse
14,0 cm **01-258-14**



gebogen, gezahnt
curved, serrated

Beuse
14,0 cm **01-259-14**

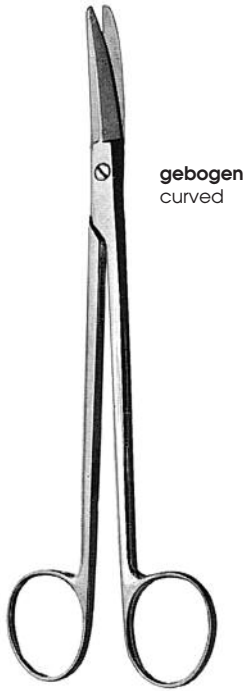

gebogen
curved

Böttcher
 18,0 cm 01-301-18



Dean
 17,0 cm 01-305-17



gezahnt
serrated

Dean
 17,0 cm 01-307-17



gebogen
curved

Good
 19,0 cm 01-309-19



gebogen,gezahnt
curved, serrated

Good-Schwekendieck
 19,0 cm 01-311-19

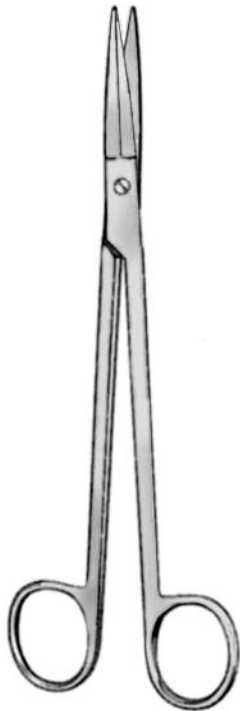

Mc Indoe
 19,0 cm 01-312-19



abgewinkelt
angled

Fomon
 13,0 cm 01-327-13

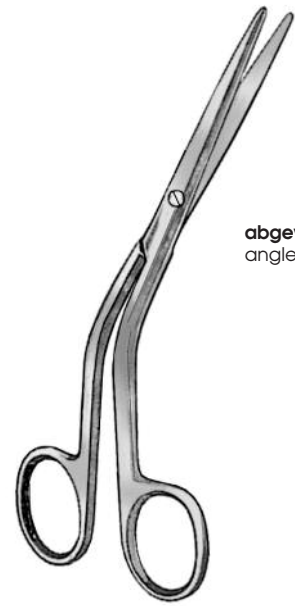

abgewinkelt
angled

Cottle
 16,0 cm 01-331-16



Heymann
18,0 cm **01-333-18**
20,0 cm **01-333-20**



Fomon
11,5 cm **01-343-11**

stark gebogen
strong curved



Fomon
13,5 cm **01-343-13**

gebogen
curved



Landolt
11,5 cm **01-345-11**

stark gebogen
strong curved



Landolt
11,5 cm **01-345-12**

gebogen
curved

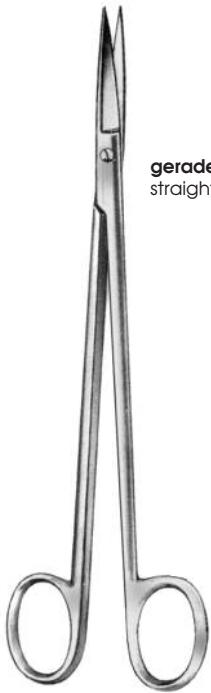

gerade
straight



gebogen
curved

Kelly

16,0 cm **01-401-16**
 18,0 cm **01-401-18**

Kelly

16,0 cm **01-400-16**
 18,0 cm **01-400-18**

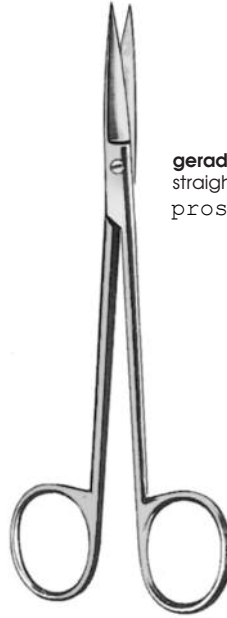

gerade
straight
proste



gebogen
curved
zakrzywione

Joseph

14,0 cm **01-405-14**

Joseph

14,0 cm **01-404-14**



gerade
straight
proste



gebogen
curved
zakrzywione

Sanvenero

14,0 cm **01-409-14**

Sanvenero

14,0 cm **01-408-14**

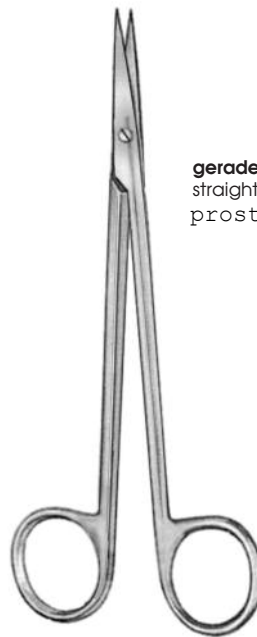

gerade
straight
proste



gebogen
curved
zakrzywione

Nerv-Präparierschere
 Nerve dissecting scissors

15,0 cm **01-411-15**

Nerv-Präparierschere
 Nerve dissecting scissors

15,0 cm **01-410-15**



gerade
straight

Goldmann-Fox
13,0 cm 01-416-13



gebogen
curved

Goldmann-Fox
13,0 cm 01-417-13

1 Schneide gezahnt
1 blade serrated



gerade
straight

Feine Schere
11,0 cm 01-418-11



gebogen
curved

Feine Schere
11,0 cm 01-419-11



gerade
straight

Wagner
Fig 1
12,0 cm 01-420-12



gebogen
curved

Fig. 1
12,0 cm 01-421-12



gerade
straight

Fig. 2
12,0 cm 01-422-12



gebogen
curved

Fig. 2
12,0 cm 01-423-12



gerade
straight

Fig. 3
12,0 cm 01-424-12



gebogen
curved

Fig. 3
12,0 cm 01-425-12



gerade
straight

Wagner, flach
 Fig 3
 12,0 cm **01-426-12**



gebogen
curved

Wagner, flach
 Fig 3
 12,0 cm **01-427-12**



gerade
straight

Feine Schere
 Delicate Scissors
 11,0 cm **01-428-11**



gebogen
curved

Feine Schere
 Delicate Scissors
 11,0 cm **01-429-11**



gebogen
curved

Littler
 11,0 cm **01-431-11**
 14,0 cm **01-431-14**



gerade
straight

Stevens
 Fig. 1
 10,0 cm **01-432-10**
 11,5 cm **01-432-11**



gebogen
curved

Stevens
 Fig. 1
 10,0 cm **01-433-10**
 11,5 cm **01-433-11**



gerade
straight

Stevens
 Fig. 3
 10,0 cm **01-434-10**
 11,5 cm **01-434-11**

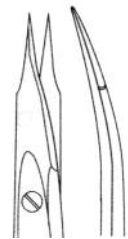

gebogen
curved

Stevens
 Fig. 3
 10,0 cm **01-435-10**
 11,5 cm **01-435-11**

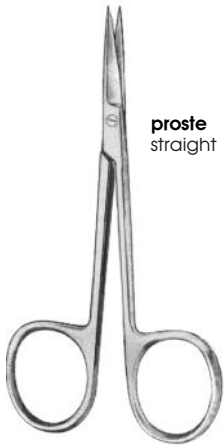

proste
straight

Iris

9,0 cm **01-440-09**
10,0 cm **01-440-10**
11,0 cm **01-440-11**
12,0 cm **01-440-12**



zakrzywione
curved

Iris

9,0 cm **01-441-09**
10,0 cm **01-441-10**
11,0 cm **01-441-11**
12,0 cm **01-441-12**



proste
straight

Iris Fino

10,0 cm **01-442-10**
11,5 cm **01-442-11**



zakrzywione
curved

Iris Fino

10,0 cm **01-443-10**
11,5 cm **01-443-11**



proste
straight

Bonn

8,0 cm **01-446-08**
9,0 cm **01-446-09**

bardzo delikatne
extra delicate



zakrzywione
curved

Bonn

8,0 cm **01-447-08**
9,0 cm **01-447-09**



pod kątem
angled

Graefe

10,0 cm **01-449-10**



zagięte
curved

La Grange

11,0 cm **01-453-11**



Satinsky
 24,0 cm 01-501-24



Klinkenbergh-Loth
 23,0 cm 01-503-23



Strully
 22,0 cm 01-505-22



Church
 17,0 cm 01-506-17

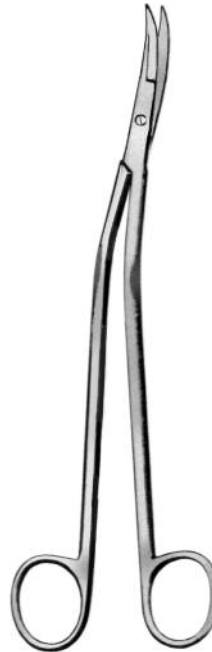
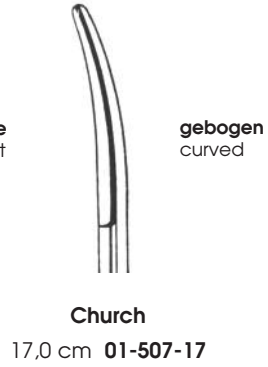

Dandy
 17,0 cm 01-511-17



Ciasson
 17,0 cm 01-513-17



Potts-Smith
19,0 cm 01-515-19

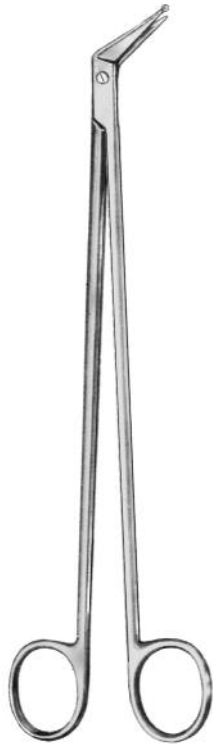

Mills
19,0 cm 01-517-19



abgewinkelt, gezahnt
angled, serrated

Locklin
16,0 cm 01-519-16



s-förmig
s-shaped

Locklin
16,0 cm 01-521-16



Schmieden-Taylor
17,0 cm 01-523-17



Favaloro
15,0 cm 01-529-15



**Coronar
mit Knopf**
with probe point
11,0 cm 01-530-11



**Coronar
mit Sondenspitze**
with probe point
11,0 cm 01-532-14

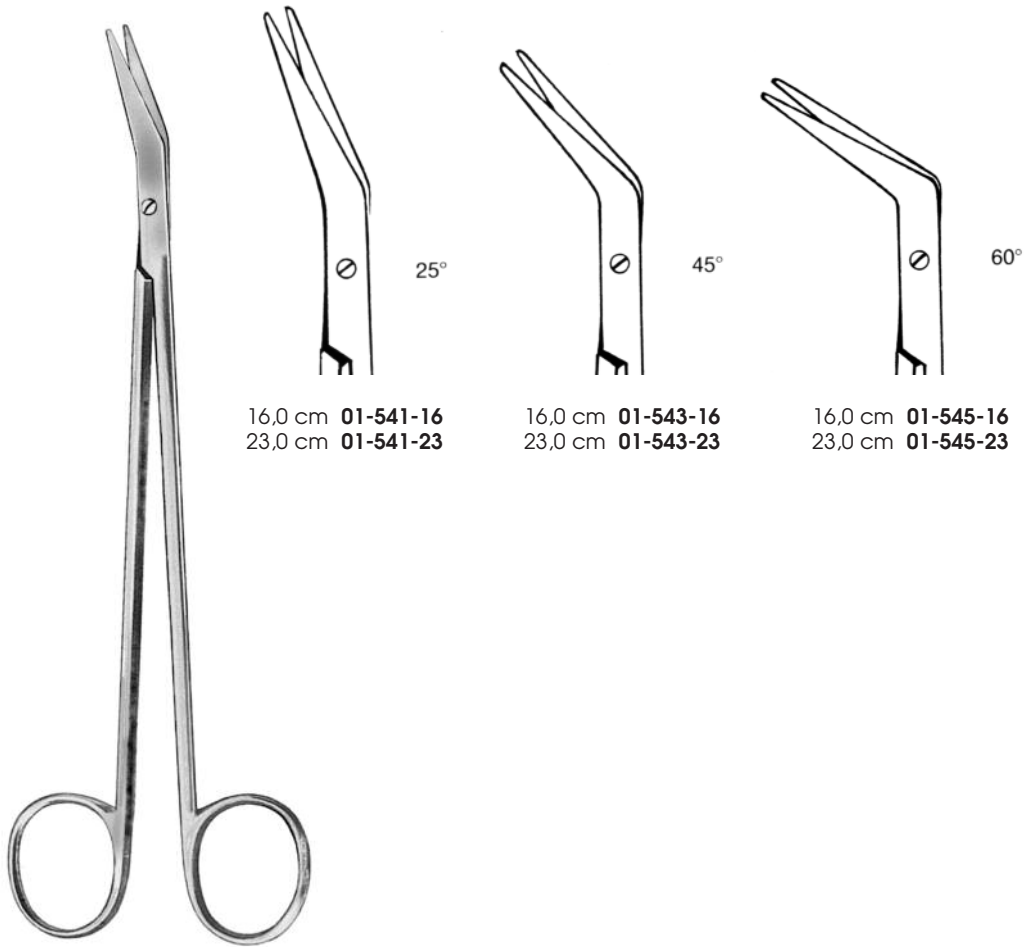

16,0 cm **01-541-16**
 23,0 cm **01-541-23**

16,0 cm **01-543-16**
 23,0 cm **01-543-23**

16,0 cm **01-545-16**
 23,0 cm **01-545-23**

De Bakey

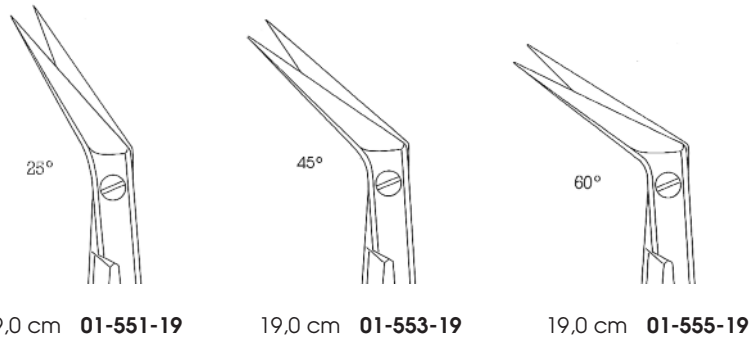

19,0 cm **01-551-19**

19,0 cm **01-553-19**

19,0 cm **01-555-19**

mit Knopf
 with probe point

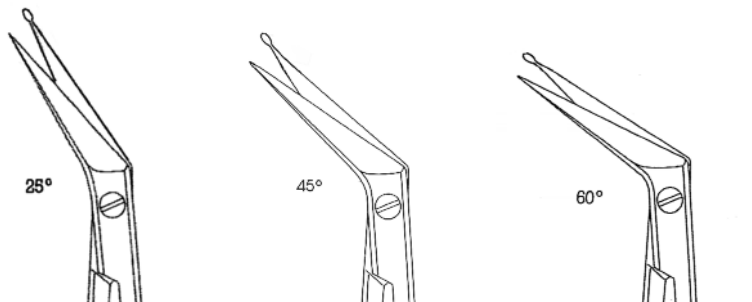

19,0 cm **01-561-19**

19,0 cm **01-563-19**

19,0 cm **01-565-19**

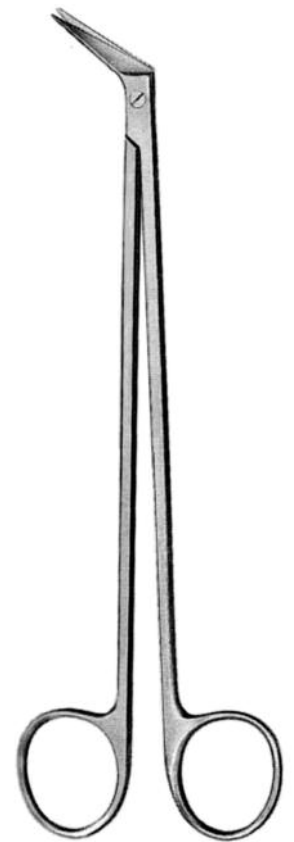

Potts-Smith

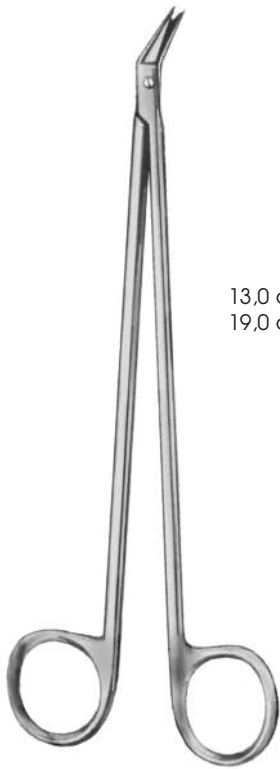

Hegemann-Diethrich

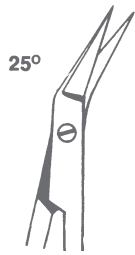

25°

13,0 cm **01-571-13**
19,0 cm **01-571-19**



45°

13,0 cm **01-573-13**
19,0 cm **01-573-19**



60°

13,0 cm **01-575-13**
19,0 cm **01-575-19**



90°

13,0 cm **01-577-13**
19,0 cm **01-577-19**



125°

19,0 cm **01-579-19**

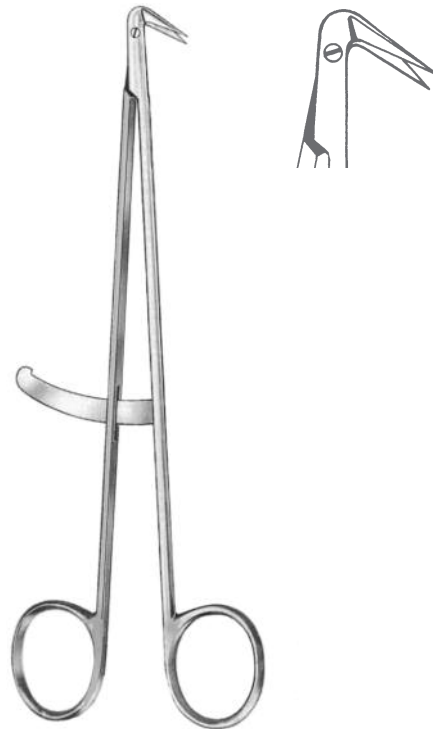

Hegemann-Diethrich
19,0 cm **01-589-19**



Vannas



gerade
 straight

8,5 cm **01-591-07**



gebogen
 curved

8,5 cm **01-591-08**



abgewinkelt
 angled

8,5 cm **01-591-09**



abgewinkelt
 angled

Castroviejo
 9,5 cm **01-593-09**



gebogen
 curved

Castroviejo
 11,0 cm **01-593-10**

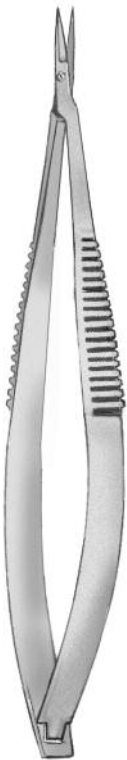

Mikro-Schere



gerade
 straight

10,5 cm **01-594-10**



gebogen
 curved

10,5 cm **01-594-11**



Wecker

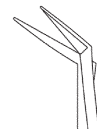

11,0 cm **01-595-10**



11,0 cm **01-595-11**



Mikro-Schere

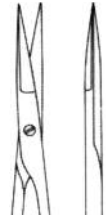

gerade
straight

15,5 cm **01-600-15**



gebogen
curved

15,5 cm **01-601-15**

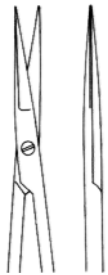

gerade
straight

19,0 cm **01-602-19**



aufgebogen
curved

19,0 cm **01-603-19**



abgebogen
curved downward

19,0 cm **01-604-19**

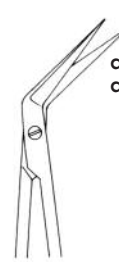

abgewinkelt
angled

19,0 cm **01-605-19**



Mikro-Schere



Mikro-Schere



gerade
 straight

23,0 cm **01-606-23**



gebogen
 curved

23,0 cm **01-607-23**



gerade
 straight

15,0 cm **01-608-15**



gebogen
 curved

15,0 cm **01-609-15**



gerade
 straight

19,0 cm **01-610-19**
 23,0 cm **01-612-23**



gebogen
 curved

19,0 cm **01-611-19**
 23,0 cm **01-613-23**



Mikro-Schere



Mikro-Schere

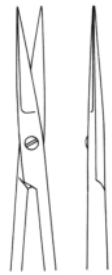

gerade
straight

18,5 cm 01-614-18



gebogen
curved

18,5 cm 01-615-18



abgewinkelt
angled

18,5 cm 01-616-18



25°

18,0 cm 01-617-18



45°

18,0 cm 01-618-18

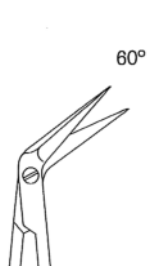

60°

18,0 cm 01-619-18

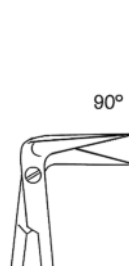

90°

18,0 cm 01-620-18



125°

18,0 cm 01-621-18



Mikro-Schere



mit Knopf
 with probe point



25°

18,0 cm **01-622-18**



45°

18,0 cm **01-623-18**



60°

18,0 cm **01-624-18**

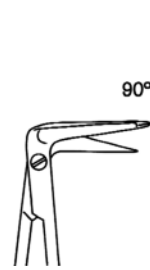

90°

18,0 cm **01-625-18**

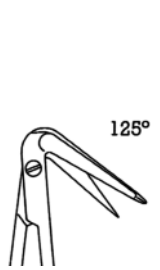

125°

18,0 cm **01-626-18**

Mikro-Schere



15,0 cm **01-627-15**



14,0 cm **01-628-14**



15,5 cm **01-629-15**



1 Blatt gezahnt
 1 blade serrated

Mikro-Schere

Reill



Westcott



gerade
straight

11,0 cm 01-630-11



gebogen
curved

11,0 cm 01-631-11



Mikro-Schere
12,0 cm 01-632-12



gerade
straight



Mikro-Schere
11,0 cm 01-633-11



gebogen
curved



Mikro-Schere
9,0 cm 01-634-09



gerade
straight



Mikro-Schere
9,0 cm 01-635-09



abgewinkelt
angled



Yasargil

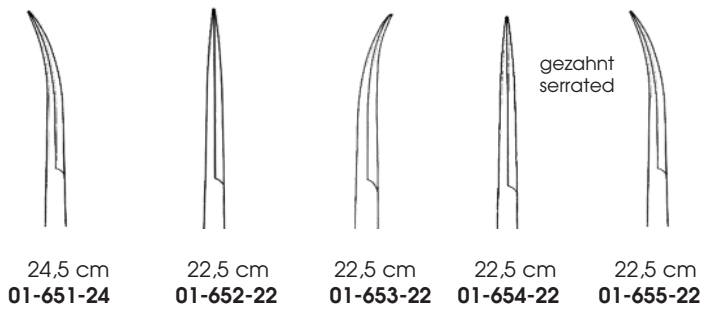

24,5 cm **01-651-24** 22,5 cm **01-652-22** 22,5 cm **01-653-22** 22,5 cm **01-654-22** 22,5 cm **01-655-22**

gezahnt
serrated



Vannas

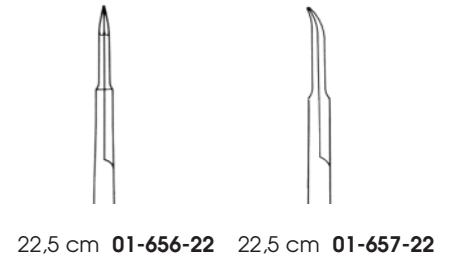

22,5 cm **01-656-22** 22,5 cm **01-657-22**



Mikro-Schere

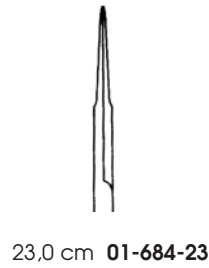

23,0 cm **01-684-23**



Mikro-Schere



14,5 cm **01-810-14** 14,5 cm **01-811-14** 14,5 cm **01-843-14**

Präparierschere
 Dissecting Scissors



Spencer
9,0 cm **01-700-09**
10,0 cm **01-700-10**
12,0 cm **01-700-12**



Spencer
11,0 cm **01-701-11**



Northbent
13,0 cm **01-705-13**

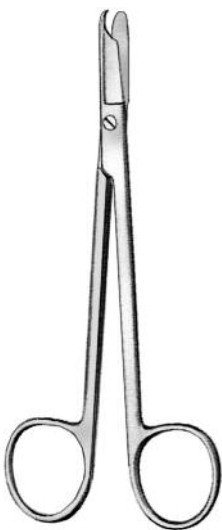

Littauer
13,0 cm **01-706-13**
14,0 cm **01-706-14**
16,0 cm **01-706-16**



Buck
14,0 cm **01-708-14**
18,0 cm **01-708-18**



Eiselberg
12,0 cm **01-710-12**



Schoemaker-Loth
 12,0 cm 01-712-12



Beebe

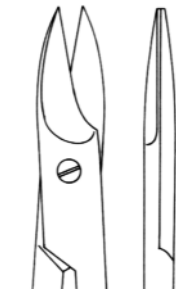

10,0 cm 01-714-10
 12,0 cm 01-714-12



10,0 cm 01-715-10
 12,0 cm 01-715-12

gezahnt
 serrated

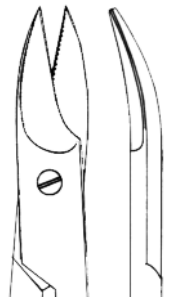

12,0 cm 01-719-12

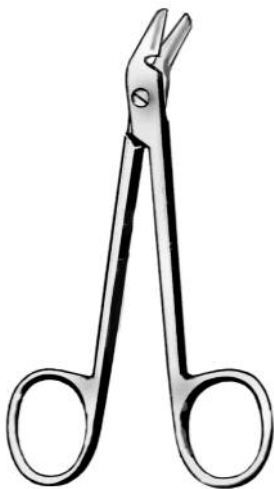

Universal
 12,0 cm 01-721-12

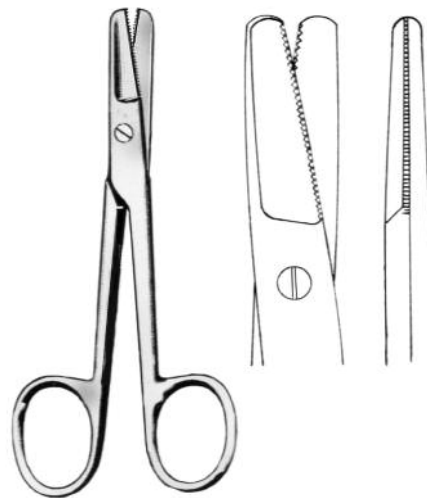

Harvey
 12,0 cm 01-722-12